

memmert

SNxx SFxx



OPERATING INSTRUCTIONS

STERILISER S

MADE IN GERMANY.

www.memmert.com

Manufacturer and customer service

Memmert GmbH + Co. KG
Willi-Memmert-Straße 90–96
D-91186 Büchenbach
Deutschland

Phone: +49 (0)9122 925-0
Fax: +49 (0)9122 14585
E-mail: sales@memmert.com
Internet: www.memmert.com

Customer service:

Service hotline: +49 (0)9171 9792 911
Service fax: +49 (0)9171 9792 979
E-mail: service@memmert.com

When contacting customer service, always quote the product serial number on the nameplate (see page 12).

Shipping address for repairs:

Memmert GmbH + Co. KG
Kundenservice
Willi-Memmert-Str. 90-96
DE-91186 Büchenbach
Germany

Please contact our customer service before sending appliances for repair or before returning equipment, otherwise, we have to refuse acceptance of the shipment.

© 2019 MEMMERT GmbH + Co. KG

D33347 | Date 12/2019

We reserve the right to make changes

About this manual

Purpose and target group

This manual describes the assembly, function, transport and operation of sterilisers SNxx and SFxx. It is intended for use by trained personnel of the owner who have the task of operating and/or maintaining the respective appliance.

If you are asked to work on the appliance, read this manual carefully before starting. Familiarise yourself with the safety regulations. Only perform work that is described in this manual. If there is something you do not understand, or certain information is missing, ask your superior or contact the manufacturer. Do not do anything without authorisation.

Versions

The appliances are available in different configurations and sizes. If specific equipment features or functions are available only for certain configurations, this is indicated at the relevant points in this manual.

The functions described in this manual refer to the latest firmware version.

Due to individual configurations and sizes, illustrations in this manual may be slightly different from the actual appearance. Function and operation are identical.

Other documents that have to be observed:

- ▶ For operation of the appliance with MEMMERT AtmoCONTROL, observe the separate software manual
- ▶ For service and repair (see page 46), please refer to the separate service manual

Storage and forwarding

This instruction manual belongs with the appliance and should always be stored where persons working on the appliance have access to it. It is the responsibility of the owner to ensure that persons who are working or will work on the appliance are informed as to the whereabouts of this instruction manual. We recommend that it is always stored in a protected location close to the appliance. Make sure that the instruction manual is not damaged by heat or humidity. If the appliance is sold on or transported and then set up again at a different location, the operating instructions must go with it.

You will find the current version of our operating manual as pdf file if you go to www.memmert.com/de/service/downloads/bedienungsanleitung/.

Contents

| | |
|--|-----------|
| 1. For your Safety | 6 |
| 1.1 Terms and signs used | 6 |
| 1.1.1 Terms used | 6 |
| 1.1.2 Signs used | 6 |
| 1.2 Product safety and dangers | 7 |
| 1.3 Requirements of the operating personnel | 7 |
| 1.4 Responsibility of the owner | 8 |
| 1.5 Intended use | 8 |
| 1.6 Changes and alterations | 8 |
| 1.7 Behaviour in case of malfunctions and irregularities | 9 |
| 1.8 Switching off the appliance in an emergency | 9 |
| 2. Construction and description | 10 |
| 2.1 Construction | 10 |
| 2.2 Function | 11 |
| 2.3 Material | 11 |
| 2.4 Electrical equipment | 11 |
| 2.5 Connections and interfaces | 12 |
| 2.5.1 Electrical connection | 12 |
| 2.5.2 Communication interface | 12 |
| 2.6 Designation (nameplate) | 12 |
| 2.7 Technical data | 13 |
| 2.8 Applied directive | 14 |
| 2.9 Declaration of conformity | 14 |
| 2.10 Ambient conditions | 14 |
| 2.11 Scope of delivery | 15 |
| 2.12 Optional accessories | 15 |
| 3. Delivery, transport and setting up | 16 |
| 3.1 For your Safety | 16 |
| 3.2 Delivery | 17 |
| 3.3 Transport | 17 |
| 3.4 Unpacking | 17 |
| 3.4.1 Checking for completeness and transport damage | 17 |
| 3.4.2 Removing the transport protection | 17 |
| 3.4.3 Disposing of packaging material | 17 |
| 3.5 Storage after delivery | 17 |
| 3.6 Setting up | 18 |
| 3.6.1 Prerequisites | 18 |
| 3.6.2 Installation options | 19 |
| 3.6.3 Tilt protection | 20 |
| 3.6.4 Adjusting the doors (only for model sizes 450 and 750) | 21 |
| 4. Putting into operation | 22 |
| 4.1 Connecting the appliance | 22 |
| 4.2 Switching on | 23 |
| 5. Operation and control | 24 |
| 5.1 Operating personnel | 24 |
| 5.2 Opening the door | 24 |

| | | |
|------------|---|-----------|
| 5.3 | Loading the appliance | 25 |
| 5.4 | Operating the appliance..... | 25 |
| 5.4.1 | ControlCOCKPIT | 25 |
| 5.4.2 | Basic operation..... | 27 |
| 5.4.3 | Operating modes | 27 |
| 5.4.4 | Manual mode..... | 28 |
| 5.4.5 | Operation with digital backwards counter with target time setting, adjustable from 1 minute to 99 days (Timer) | 28 |
| 5.5 | Temperature monitoring | 29 |
| 5.5.1 | Electronic temperature monitoring | 30 |
| 5.5.2 | Mechanical temperature monitoring: Temperature limiter (TB)..... | 31 |
| 5.5.3 | Function | 31 |
| 5.6 | Ending operation..... | 31 |
| 6. | Malfunctions, warning and error messages | 32 |
| 6.1 | Warning messages of the temperature monitoring function | 32 |
| 6.2 | Malfunctions, operating problems and appliance errors | 33 |
| 6.3 | Power failure..... | 34 |
| 7. | Menu mode | 35 |
| 7.1 | Overview | 35 |
| 7.2 | Basic operation in menu mode using the example of language selection..... | 36 |
| 7.3 | Setup..... | 37 |
| 7.3.1 | IP address and subnet mask | 37 |
| 7.3.2 | Unit..... | 38 |
| 7.3.3 | Temperature monitoring (Alarm Temp and Max Alarm) | 38 |
| 7.3.4 | Timer Mode..... | 40 |
| 7.3.5 | Type of the slide-in unit (Grid or Shelf) | 40 |
| 7.3.6 | Remote control | 40 |
| 7.3.7 | Gateway | 41 |
| 7.4 | Date and Time | 41 |
| 7.5 | Calibration | 42 |
| 8. | Notes on sterilisation | 45 |
| 8.1 | Contraindications / unwanted side effects..... | 45 |
| 8.2 | Note in accordance with Medical Devices Directive | 45 |
| 8.3 | Guidelines for sterilisation | 45 |
| 9. | Maintenance and service | 46 |
| 9.1 | Cleaning..... | 46 |
| 9.1.1 | Working chamber and metal surfaces..... | 46 |
| 9.1.2 | Plastic parts | 46 |
| 9.1.3 | Glass surfaces..... | 46 |
| 9.2 | Regular maintenance..... | 46 |
| 9.3 | Repairs and service | 46 |
| 10. | Storage and disposal | 47 |
| 10.1 | Storage | 47 |
| 10.2 | Disposal | 47 |
| | Index | 48 |
| | Appendix | 50 |

1. For your Safety

1.1 Terms and signs used

In this manual and on the appliance itself, certain common terms and signs are used to warn you of possible dangers or to give you hints that are important in avoiding injury or damage. Observe and follow these hints and regulations to avoid accidents and damage. These terms and signs are explained below.

1.1.1 Terms used

"Warning" is used whenever you or somebody else could be injured if you do not observe the accompanying safety regulation.

"Caution" is used for information that is important for avoiding damage.

1.1.2 Signs used

| Warning signs (warning of a danger) | | | | | |
|--|--|---------------------------|--|-------------------------|--|
| | | | | | |
| Danger of electrocution | Danger of explosion | Dangerous gases / vapours | Danger of burns | Danger of toppling over | Hazard area! Observe the operating instructions |
| Prohibition signs (forbidding an action) | | | | | |
| | | | | | |
| Do not lift | Do not tilt | Do not enter | | | |
| Regulation signs (stipulating an action) | | | | | |
| | | | | | |
| Disconnect the mains plug | Wear gloves | Wear safety boots | Observe information in separate manual | | |
| Other icons | | | | | |
| | Important or useful additional information | | | | |

1.2 Product safety and dangers

The appliances described in this manual are technically sophisticated, manufactured using high-quality materials and subject to many hours of testing in the factory. They contain the latest technology and comply with recognised technical safety regulations. However, there are still risks involved, even when the appliances are used as intended. These are described below.



Warning!

After removing covers, live parts may be exposed. You may receive an electric shock if you touch these parts. Disconnect the mains plug before removing any covers. Only electrical technicians may work on the electrical equipment of the appliances.



Warning!

When loading the appliance with an unsuitable load, poisonous or explosive vapours or gases may be produced. This could cause the appliance to explode, and persons could be severely injured or poisoned. The appliance may only be loaded with materials/test objects which do not form any toxic or explosive vapours when heated up (see also Intended use on page 8).



Warning!

If the door is open while the appliance is in operation, the appliance may overheat and pose a fire hazard. Do not leave the door open during operation.



Warning!

Depending on operation, the surfaces in the working chamber and the chamber load may still be very hot after the appliance is switched off. Touching these surfaces can cause burns. Wear heat-resistant protective gloves or wait until the appliance cools down.



Warning!

In case of appliances of a certain size, you can get accidentally locked in, which is life-threatening. Do not climb into the appliance!

1.3 Requirements of the operating personnel

The appliance may only be operated and maintained by persons who are of legal age and have been instructed accordingly. Personnel who are to be trained, instructed or who are undergoing general training may only work with the appliance under the continuous supervision of an experienced person.

Repairs may only be performed by qualified electricians. The regulations in the separate service manual must be observed.

1.4 Responsibility of the owner

The owner of the appliance

- ▶ is responsible for the flawless condition of the appliance and for its proper operation in accordance with its intended use (see page 8);
- ▶ is responsible for ensuring that persons who are to operate or service the appliance are qualified to do this, have been instructed accordingly and are familiar with the operating instructions at hand;
- ▶ must know about the applicable guidelines, requirements and operational safety regulations, and train staff accordingly;
- ▶ is responsible for ensuring that unauthorised persons have no access to the appliance;
- ▶ is responsible for ensuring that the maintenance plan is adhered to and that maintenance work is carried out properly (see page 46);
- ▶ has to ensure that the appliance and its surroundings are kept clean and tidy, for example through corresponding instructions and inspections;
- ▶ is responsible for ensuring that personal protective clothing is worn by operating personnel, e.g. work clothes, safety shoes and protective gloves.

1.5 Intended use

This appliance is exclusively intended for heating up non-explosive substances and objects. Any other use is improper, and may result in hazards and damage.

The appliance is not explosion-proof (does not comply with the German workplace health & safety regulation VBG 24). The appliance may only be loaded with materials and substances which cannot form any toxic or explosive vapours at the set temperature and which cannot explode, burst or ignite.

The appliance may not be used for drying, vaporising and branding paints or similar materials the solvents of which could form an explosive mixture when combined with air. If there is any doubt as to the composition of materials, they must not be loaded into the appliance. Potentially explosive gas-air mixtures must not form, neither in the working chamber nor in the direct vicinity of the appliance.

Intended use

In accordance with the Medical Devices Directive 93/42/EEC, the following intended purpose applies: The appliance is intended to sterilise medical material using dry heat at atmospheric pressure.

1.6 Changes and alterations

No unauthorised changes or alterations may be made to the appliance. No parts may be added or inserted which have not been approved by the manufacturer.

Unauthorised modifications or changes result in the CE declaration of conformity losing its validity and the appliance must no longer be operated.

The manufacturer is not liable for any damage, danger or injuries that result from unauthorised changes or alterations, or from non-observance of the regulations in this manual.

1.7 Behaviour in case of malfunctions and irregularities

The appliance may only be used in a flawless condition. If you as the operator notice irregularities, malfunctions or damage, immediately take the appliance out of service and inform your superior.

i You can find information on correcting malfunctions from page 32.

1.8 Switching off the appliance in an emergency

Push the On/Off switch on the control panel (Fig. 1) and disconnect power plug. This disconnects the appliance from the power supply at all poles.

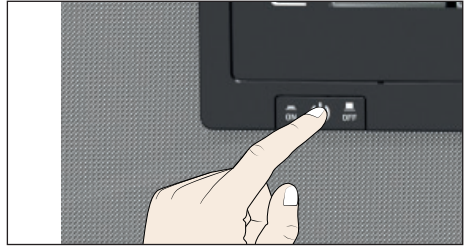

Fig. 1
Switch off the appliance by pressing the On/Off switch



Warning!

Depending on the operation performed, the surfaces in the working chamber and the chamber load may still be very hot after the appliance is switched off. Touching these surfaces can cause burns. Wear heat-resistant protective gloves or wait until the appliance cools down.



2. Construction and description

2.1 Construction



Fig. 2 Construction

- | | |
|--|--------------------------------------|
| 1 ControlCOCKPIT with capacitive function keys (see page 26) | 4 Steel grid |
| 2 On/Off switch (see page 23) | 5 Working chamber |
| 3 Working chamber fan (for UF/IF/SF appliances only) | 6 Nameplate (covered, see page 12) |
| | 7 Door handle (see page 24) |
| | 8 Turn control with confirmation key |

2.2 Function

Appliances of the SNxx type series feature natural circulation (convection). For the SFxx type series, air is circulated by a fan on the rear panel of the interior chamber Fig. 3, No. 1). It increases the air flow and provides stronger horizontal forced air circulation than natural convection.

In both the convection and fan ventilated appliances, supply air (2) is preheated in a pre-heating chamber (3). Through the ventilation slits in the side panel of the working chamber, the pre-heated air is introduced into the interior of the chamber. The supply and exhaust air (5) volume (air change) is controlled by the air flap (4) on the rear panel of the appliance.

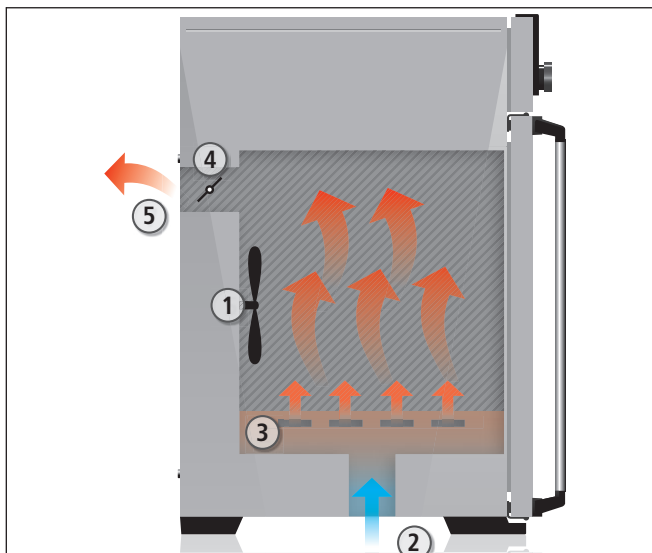

Fig. 3 Function

- 1 Fan
- 2 Fresh air
- 3 Pre-heating chamber
- 4 Air flap
- 5 Exhaust air

2.3 Material

For the outer housing, MEMMERT deploys stainless steel (Mat.No. 1.4016 – ASTM 430) and for the interior, stainless steel (Mat.No. 1.4301 – ASTM 304) is used, which stands out through its high stability, optimal hygienic properties and corrosion-resistance towards many (but not all!) chemical compounds (caution for example with chlorine compounds).

The chamber load for the appliance must be carefully checked for chemical compatibility with the materials mentioned. A material resistance table can be requested from the manufacturer.

2.4 Electrical equipment

- ▶ Operating voltage and current consumption: See nameplate
- ▶ Protection class I, i.e. operating insulation with PE conductor in accordance with EN 61010
- ▶ Protection type IP 20 acc. to EN 60 529
- ▶ Appliance fuse: Fusible link 250 V/15 A quick-blow
- ▶ The temperature controller is protected with a miniature fuse 100 mA (160 mA at 115 V)

2.5 Connections and interfaces

2.5.1 Electrical connection

This appliance is intended for operation on an electrical power system with a system impedance Z_{max} of a maximum of 0.292 ohm at the point of transfer (service line). The operator must ensure that the appliance is operated only on an electrical power system that meets these requirements. If necessary, you can ask your local energy supply company what the system impedance is.

Observe the country-specific regulations when connecting (e.g. in Germany DIN VDE 0100 with residual current circuit breaker).

2.5.2 Communication interface

The Ethernet interface is intended for appliances which meet the requirements of IEC 60950-1.

Via Ethernet interface, the appliance can be connected to a network to read out protocol logs with AtmoCONTROL, the optional appliance software. The Ethernet interface is located on the rear of the appliance (Fig. 4).

For identification purposes, each appliance connected must have its own unique IP address. Setting the IP address is described on page 37.

With an optional USB to Ethernet converter, the appliance can be directly connected to a computer / laptop (see Optional accessories on page 15).

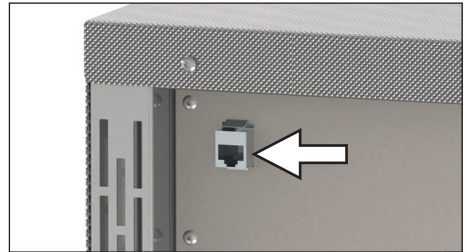

Fig. 4 Ethernet interface

2.6 Designation (nameplate)

The nameplate (Fig. 5) provides information about the appliance model, manufacturer and technical data. It is attached to the front of the appliance, on the right side under the door (see page 10).

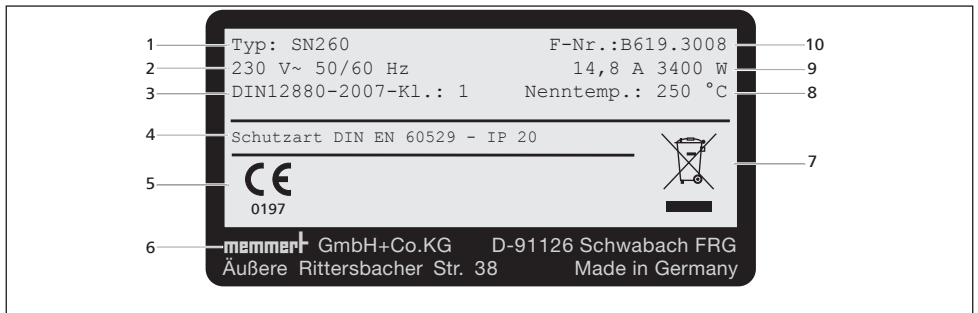

Fig. 5 Nameplate (example)

- 1 Type designation
- 2 Operating voltage
- 3 Applied standard
- 4 Protection type
- 5 CE conformity with the number of the notified body

- 6 Address of manufacturer
- 7 Disposal note
- 8 Temperature range
- 9 Connection / power ratings
- 10 Appliance number

2.7 Technical data

| Appliance size | 30 | 55 | 75 | 110 | 160 | 260 | 450 | 750 |
|---|-------------------------------------|------|------|------|------|------|---------|----------|
| Appliance width D ¹ [mm] | 585 | 585 | 585 | 745 | 745 | 824 | 1224 | 1224 |
| Appliance height E ¹ [mm] | 707 | 787 | 947 | 867 | 1107 | 1186 | 1247 | 1720 |
| Appliance depth F ¹ (footprint) [mm] | 434 | 514 | 514 | 584 | 584 | 684 | 784 | 784 |
| Depth of door lock [mm] | 56 | | | | | | | |
| Working chamber width A ¹ [mm] | 400 | 400 | 400 | 560 | 560 | 640 | 1040 | 1040 |
| Working chamber height B ¹ [mm] | 320 | 400 | 560 | 480 | 720 | 800 | 720 | 1200 |
| Working chamber depth C ¹ [mm] | 250 | 330 | 330 | 400 | 400 | 500 | 600 | 600 |
| Chamber volume [litres] | 32 | 53 | 74 | 108 | 161 | 256 | 449 | 749 |
| Weight [kg] | 48 | 57 | 66 | 78 | 96 | 110 | 170 | 217 |
| Power [W] | 230 V, 50/60 Hz | 1600 | 2000 | 2500 | 2800 | 3200 | 3400 | - |
| | 115 V, 50/60 Hz | 1600 | 1700 | 1800 | 1800 | 1800 | 1800 | - |
| | 400 V, 50/60 Hz | - | - | - | - | - | 5800 | 7000 |
| Current consumption [A] | 3 x 230 V without zero | - | - | - | - | - | 5800 | 7000 |
| | 3 x 208 V, 50/60 Hz | - | - | - | - | - | 4800 | 5700 |
| | 230 V, 50/60 Hz | 7,0 | 8,7 | 10,9 | 12,2 | 13,9 | 14,8 | - |
| max. number of sliding shelves | 115 V, 50/60 Hz | 13,9 | 14,8 | 15,6 | 15,6 | 15,6 | - | - |
| | 400 V, 50/60 Hz | - | - | - | - | - | 3 x 8,4 | 3 x 10,2 |
| | 3 x 230 V without zero | - | - | - | - | - | 3 x 8,4 | 3 x 10,2 |
| max. load per sliding shelf [kg] | 3 x 208 V, 50/60 Hz | 3 | 4 | 6 | 5 | 8 | 9 | 14 |
| | 230 V, 50/60 Hz | 30 | 30 | 30 | 30 | 30 | 30 | 30 |
| | 115 V, 50/60 Hz | 60 | 80 | 120 | 175 | 210 | 210 | 300 |
| Setting temperature range | +20 bis +250 °C ² | | | | | | | |
| Adjustment precision | bis 100 °C: 0,1 K, ab 100 °C: 0,5 K | | | | | | | |

¹ See Fig. 6 on page 14.

² With the interior lighting on, the minimum temperature might not be reached.

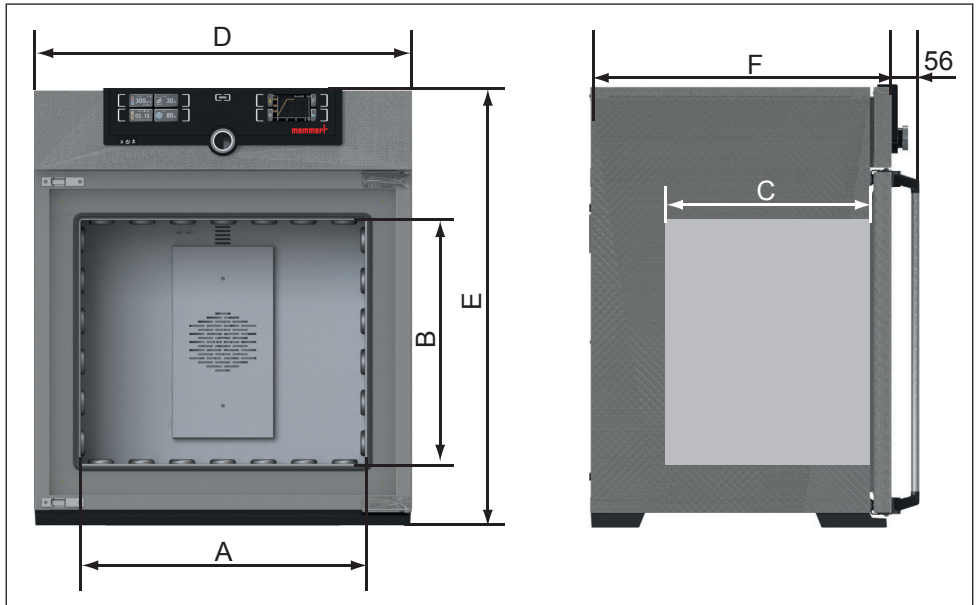

Fig. 6 Dimensions (see table on page 13)

2.8 Applied directive

Based on the standards and guidelines listed in the following, the products described in this manual have received a CE label from the company Memmert:

Directive 93/42/EEC (Directive of the Commission on the harmonisation of the legal regulations of the member states on medical devices)



2.9 Declaration of conformity

You will find the EC declaration of conformity for the appliance enclosed in this manual.

2.10 Ambient conditions

- ▶ The appliance may only be used in enclosed rooms and under the following ambient conditions:

| | |
|--------------------------|------------------------------|
| Ambient temperature | +5 °C to +40 °C |
| Humidity rh | max. 80 %, non-condensing |
| Overvoltage category | II |
| Pollution degree | 2 |
| Altitude of installation | max. 2,000 m above sea level |

- ▶ The appliance may not be used in areas where there is a risk of explosion. The ambient air must not contain any explosive dusts, gases, vapours or gas-air mixtures. The appliance is not explosion-proof.
- ▶ Heavy dust production or aggressive vapours in the vicinity of the appliance could lead to sedimentation in the interior and, as a consequence, could result in short circuits or damage to electrical parts. For this reason, sufficient measures to prevent large clouds of dust or aggressive vapours from developing should be taken.

2.11 Scope of delivery

- ▶ Power cable
- ▶ Tilt protection
- ▶ One or two sliding steel grids (load capacity 30 kg each)
- ▶ The operating instructions at hand
- ▶ Calibration certificate

2.12 Optional accessories

- ▶ AtmoCONTROL software for reading out and processing of protocol log files
- ▶ USB to Ethernet converter (Fig. 7). Makes it possible to connect the appliance's network interface (see page 12) to the USB port of a computer / laptop.
- ▶ Reinforced, sliding steel grids with a load capacity of 60 kg each (for appliance size 110 and larger)

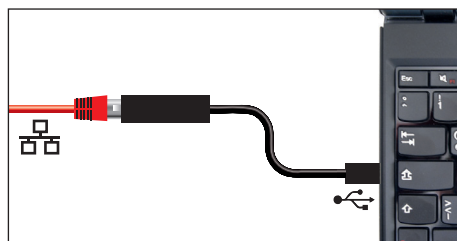

Fig. 7 Converter USB to Ethernet

3. Delivery, transport and setting up

3.1 For your Safety



Warning!

Because of the heavy weight of the appliance, you could injure yourself if you try to lift it. To carry appliances of the sizes 30 and 55, at least two persons, for appliances of the sizes 75, 110, 160 and 260, four people are needed. Appliances larger than that may not be carried but must be transported with a manual pallet jack or forklift truck.

| 30 | 55 | 75 | 110 | 160 | 260 | 450 | 750 |
|----|----|----|-----|-----|-----|-----|-----|
| | | | | | | | |



Warning!

You may get your hands or feet squashed when transporting and installing the appliance. Wear protective gloves and safety boots. When grasping the bottom of the appliance, grasp it only on the sides:



Warning!

The appliance could fall over and seriously injure you. Never tilt the appliance and transport it in upright position and without load only (except for standard accessories such as steel grids or shelves). Appliances with castors always have to be moved by two people.

3.2 Delivery

The appliance is packed in cardboard and is delivered on a wooden palette.

3.3 Transport

The appliance can be transported in three ways:

- ▶ With a forklift truck; move the forks of the truck entirely under the pallet
- ▶ On a manual pallet jack
- ▶ On its own castors, in case of the corresponding configuration, for which the catch on the (front) castors must be released

3.4 Unpacking

i To avoid damage, do not unpack the appliance until you reach the installation site.

Remove the cardboard packaging by pulling it upwards or carefully cutting along an edge.

3.4.1 Checking for completeness and transport damage

- ▶ Check the delivery note to ensure that the delivery is complete.
- ▶ Check the appliance for damage.

If you notice deviations from the delivery note, damage or irregularities, do not put the appliance into operation but inform the haulage company and the manufacturer.

3.4.2 Removing the transport protection

Remove the transport protection. It is located between the door hinge, door and frame and has to be removed after opening the door.

3.4.3 Disposing of packaging material

Dispose of the packaging material (cardboard, wood, foil) in accordance with the applicable disposal regulations for the respective material in your country.

3.5 Storage after delivery

If the appliance is first to be stored after delivery: Read the storage conditions from page 47.

3.6 Setting up



Warning!

Due to its centre of gravity, the appliance can fall over to the front and injure you or other people. Always attach the appliance to a wall with the tilt protection (see page 20). If this cannot be done due to space problems, do not operate the appliance and do not open the door. Contact the Memmert service team (see page 2).

3.6.1 Prerequisites

The installation site must be flat and horizontal and must be able to reliably bear the weight of the appliance (see Technical data on page 13). Do not place the appliance on a flammable surface.

Depending on the model (see nameplate), a 230 V, 115 V or 400 V power connection must be available at the installation site.

The distance between the wall and the rear of the appliance must be at least 15 cm. The clearance from the ceiling must not be less than 20 cm and the side clearance from walls or nearby appliances must not be less than 5 cm (Fig. 8). Sufficient air circulation in the vicinity of the appliance must be guaranteed at all times.

For appliances with castors, these need to be positioned in forward direction at all times.

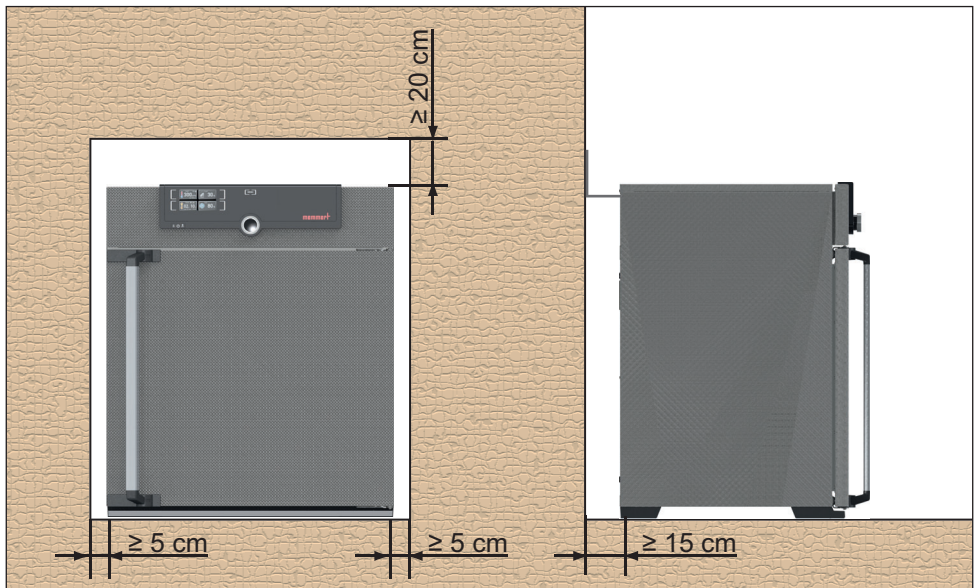









Fig. 8 Minimum clearance from walls and ceiling

3.6.2 Installation options

| Setting up | Comments | Suitable for appliance size ... | | | | | | | |
|---|--|---------------------------------|----|----|-----|-----|-----|-----|-----|
| | | 30 | 55 | 75 | 110 | 160 | 260 | 450 | 750 |
| Floor  | | ✓ | ✓ | ✓ | ✓ | ✓ | ✓ | ✓ | ✓ |
| Table  | Check the load capacity first | ✓ | ✓ | ✓ | ✓ | ✗ | ✗ | ✗ | ✗ |
| Stacked  | two appliances maximum; mounting material (feet) provided | ✓ | ✓ | ✓ | ✓ | ✗ | ✗ | ✗ | ✗ |
| Wall mounting  | Separately packaged fastening material is included in the scope of delivery. Observe the assembly instructions provided. | ✓ | ✓ | ✓ | ✓ | ✓ | ✗ | ✗ | ✗ |
| Base  | with/without castors | ✓ | ✓ | ✓ | ✓ | ✓ | ✓ | ✓ | ✗ |
| Castor frame  | | ✓ | ✓ | ✓ | ✓ | ✓ | ✓ | ✗ | ✗ |
| Height adjustable feet  | | ✓ | ✓ | ✓ | ✓ | ✓ | ✓ | ✓ | ✓ |

3.6.3 Tilt protection

Attach the appliance to a wall with the tilt protection. The tilt protection is included in the delivery.

1. As illustrated, fasten the tilt protection to the rear side of the appliance.

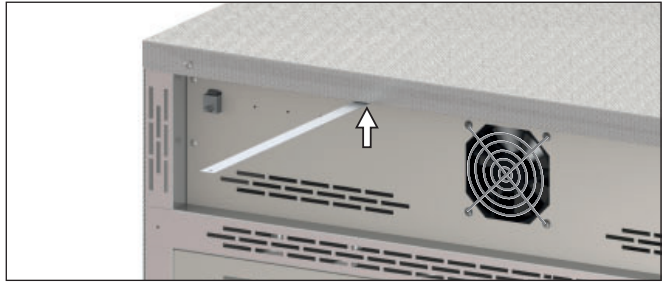

2. Bend the tilt protection upwards by 90 ° in the desired distance to the wall (consider the minimum distance to the wall, see Fig. 8).



3. Drill a hole, insert a plug and screw the tilt protection to a suitable wall.

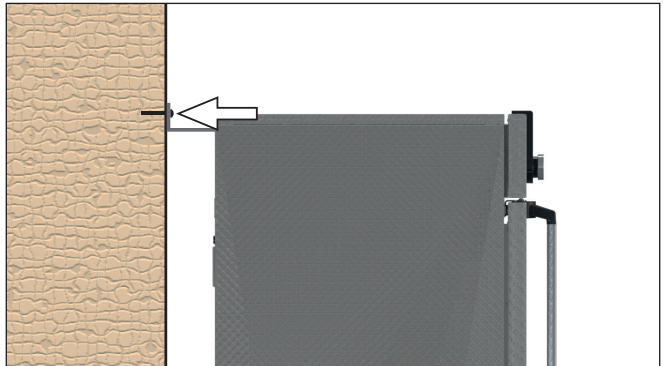

3.6.4 Adjusting the doors

For appliances it is possible to adjust doors that warp due to the floor conditions. In order to do so, every door has two adjuster screws at the top and at the bottom (Fig. 9).

1 First, adjust the door at the top and then, if further adjustment is necessary, at the bottom as well.

1. Open the door.
2. Undo the screws.
3. Adjust the door.
4. Tighten the screws again.
5. Check door alignment.
6. If necessary, readjust.

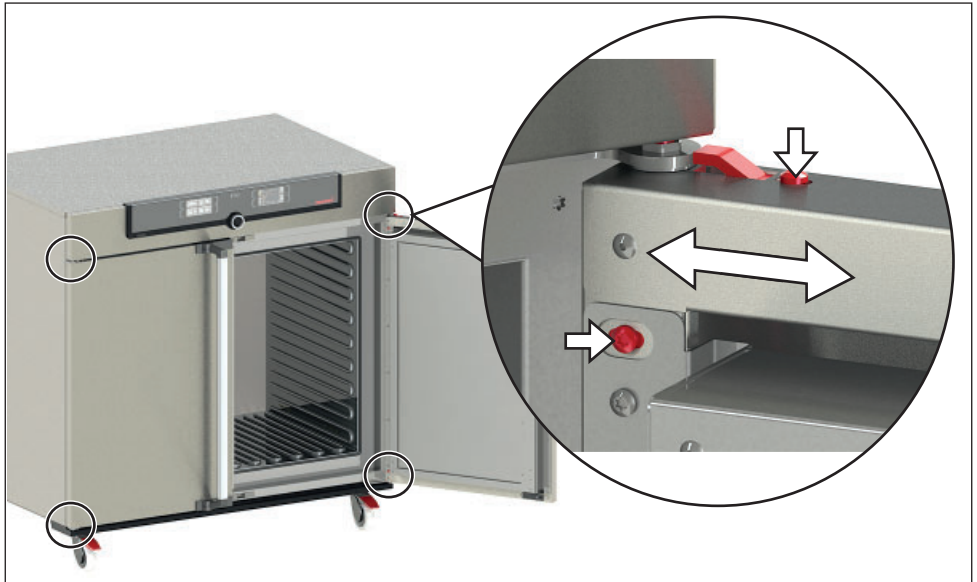

Fig. 9 Door adjustment screws

4. Putting into operation

● Caution:

i The first time the appliance is operated, it must not be left unattended until it has reached the steady state.

4.1 Connecting the appliance

⚠ WARNING



Condensation might cause a short circuit. After transport or storage at high humidity conditions, the appliance shall be stored unpacked at normal conditions for at least 24 hours. During this period of time the appliance shall not be connected to the power supply.

● Caution:

i Observe the country-specific regulations when making connections (e.g. in Germany DIN VDE 0100 with residual current circuit breaker). Observe the connection and power ratings (see nameplate and Technical data on page 13). Make sure to establish a safe PE conductor connection.

Lay the power cable so that

- ▶ it is always accessible and within reach so it can be disconnected quickly in the event of failure or emergencies;
- ▶ no one can trip over it;
- ▶ it does not come into contact with any hot parts.

230/115-V appliances:

Plug the provided power cable into the rear of the appliance and connect it to a CEE 7/4 socket (Fig. 10).

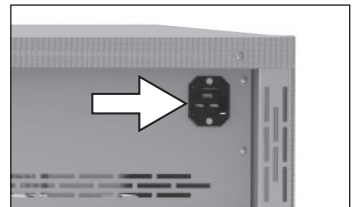

Fig. 10 Power connection
230/115 V

400V appliances:

The power cable is permanently installed. Connect the plug to a 400 V CEE coupling (Fig. 11).



Fig. 11 400 V CEE connection

4.2 Switching on

Switch on the appliance by pressing the On/Off switch on the front of the appliance (Fig. 12).

The starting process is shown by three animated white dots . If the dots have another colour, an error has occurred (see page 33).

i After the first start-up, the appliance display is set to English by default. You can change the language as described from page 36. However, to get a basic overview of operating the appliance, you should read the following chapter first.

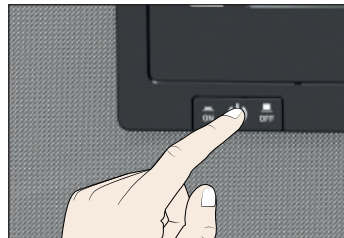

Fig. 12 Switch on appliance

5. Operation and control

i Caution:

When loading and operating sterilisers of the SN/SF type, make sure to observe the special notes provided in chapter Notes on sterilisation from page 45.

5.1 Operating personnel

The appliance may only be operated by persons who are of legal age and have been instructed accordingly. Personnel who are to be trained, instructed or who are undergoing general training may only work with the appliance under the continuous supervision of an experienced person.

5.2 Opening the door

- ▶ To open the door, pull the door handle to the side (to the left or to the right, depending on the door variation, see Fig. 13, A) and open the door completely.
- ▶ To close the appliance, push the door closed and the door handle to the side (B).

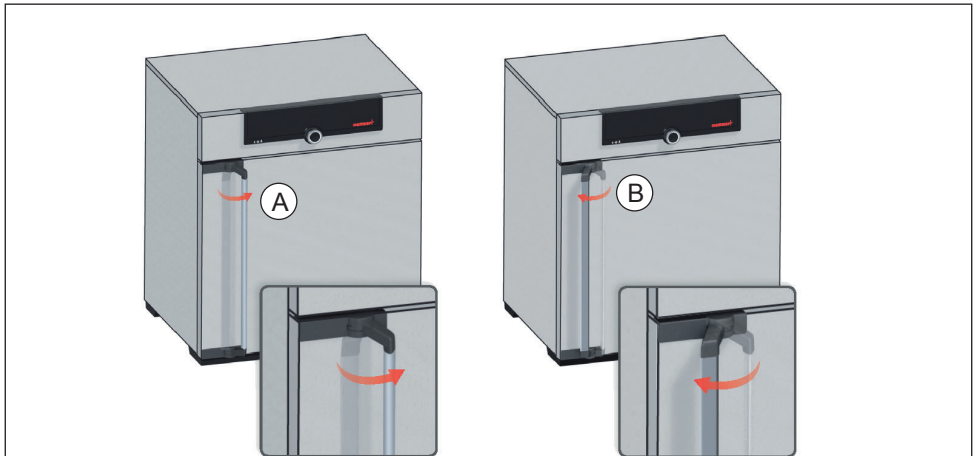

Fig. 13 Opening and closing the door



Warning!

If the door is open while the appliance is in operation, the appliance may overheat and pose a fire hazard. Do not leave the door open during operation.



Warning!

In case of appliances of a certain size, you can get accidentally locked in, which is life-threatening. Do not climb into the appliance!

5.3 Loading the appliance



Warning!

When loading the appliance with an unsuitable load, poisonous or explosive vapours or gases may be produced. This could cause the appliance to explode, and persons could be severely injured or poisoned. The appliance may only be loaded with materials which do not form any toxic or explosive vapours when heated up and cannot ignite (see also Intended use on page 8). If there is any doubt as to the composition of materials, they must not be loaded into the appliance.



i Caution:
Check the chamber load for chemical compatibility with the materials of the appliance (see page 11).

i Caution:
If the chamber load is wet or very humid, water may accumulate on the floor and damage the heater. If wet, use a drip tray on the bottom of the tube.

Insert the sliding steel grids or sliding shelves. The maximum number of grids / shelves and the load capacity are specified in the technical data overview on page 13.

The chamber must not be loaded too tightly, so that proper air circulation in the working chamber is guaranteed. Do not place any chamber load on the floor, touching the side walls or right below the ceiling of the working chamber (Fig. 14, see also the "correct loading" sticker on the appliance).

In case of improper loading (chamber loaded too tightly), the set temperature may be exceeded or it may take longer until it is reached.

i To achieve the correct heating capacity, the type of slide-in unit used – Grid or Shelf – must be set in the menu under SETUP (see page 40).

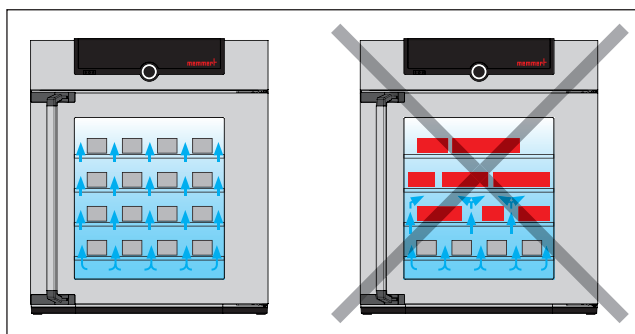

Fig. 14 Correct placement of the chamber load

5.4 Operating the appliance

5.4.1 ControlCOCKPIT

In manual operation, the desired parameters are entered at the ControlCOCKPIT on the front of the appliance (Fig. 15 and Fig. 16). You can also make basic settings here (menu). Additionally, warning messages are displayed, e.g. if the temperature is exceeded.

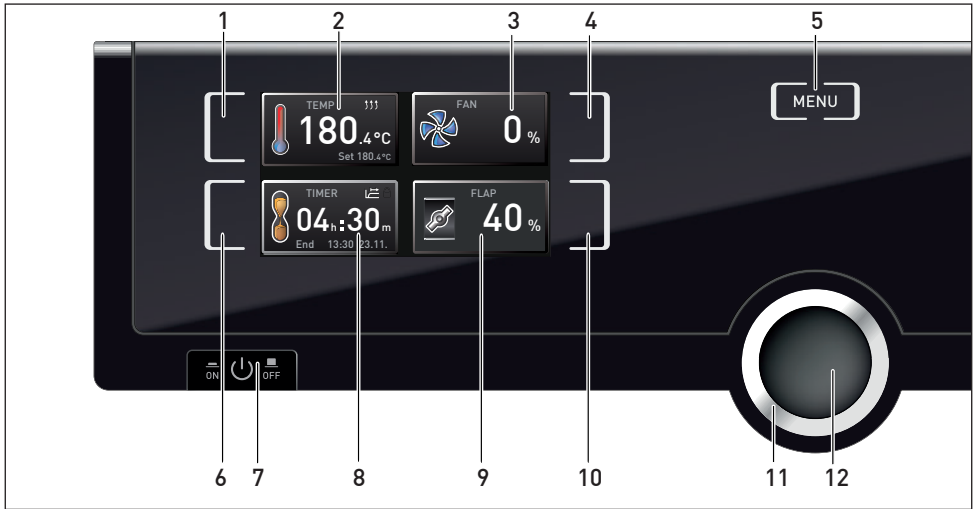

Fig. 15 ControlCOCKPIT for SF appliances in operating mode

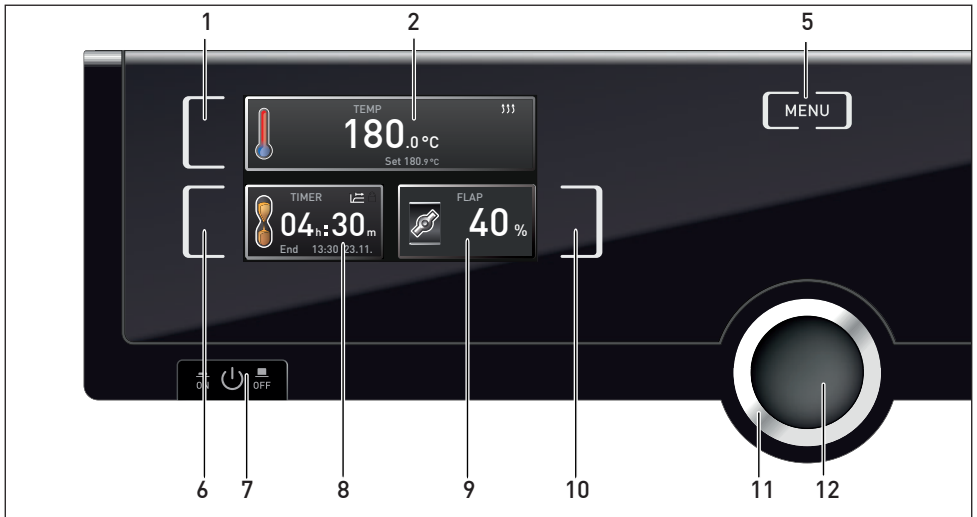

Fig. 16 ControlCOCKPIT for SN appliances in operating mode

- | | |
|--|---|
| <ul style="list-style-type: none"> 1 Activation key for temperature setpoint adjustment 2 Setpoint and actual temperature display 3 Fan speed display 4 Activation key for fan speed setting 5 Switch to menu mode (see page 35) 6 Activation key digital backwards counter with target time setting, adjustable from 1 minute to 99 days 7 On/Off switch | <ul style="list-style-type: none"> 8 Display digital backwards counter with target time setting, adjustable from 1 minute to 99 days 9 Air flap position display 10 Activation key for air flap position adjustment 11 Turn control for setpoint adjustment 12 Confirmation key (accepts setting made with the turn control) |
|--|---|

5.4.2 Basic operation

In general, all settings are made according to the following pattern:

1. Activate the desired parameter (e.g. temperature). To do so, press the corresponding activation key on the left or right of the respective display. The activated display is lined in colour, the other displays are dimmed. The set value is highlighted in colour.

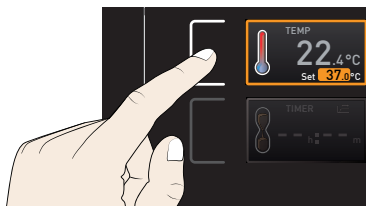

2. By turning the turn control to the left or right, adjust the set value (e.g. to 180.0 °C).

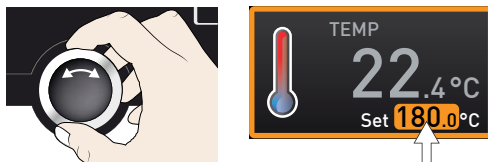

3. Save the set value by pressing the confirmation key. The display returns to normal and the appliance begins adjusting to the defined set value.

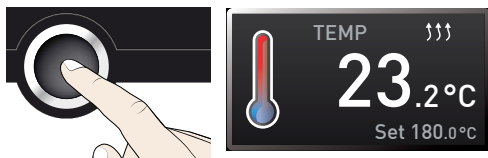

Additional parameters (air flap position etc.) can be set accordingly.

- 1 If no new values are entered or confirmed for approx. 30 seconds, the appliance automatically returns to the main menu and restores the former values.

If you want to cancel the setting procedure, press the activation key on the left or right of the display that you want to exit. The appliance restores the former values. Only the settings that you have confirmed by pressing the confirmation key before cancelling the setting procedure are accepted.

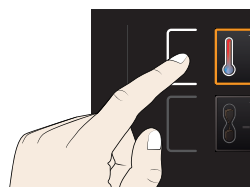

5.4.3 Operating modes

The appliance can be operated in different modes:

- ▶ **Manual mode:** The appliance runs in permanent operation at the values set on the ControlCOCKPIT. Operation in this mode is described in chapter 5.4.4.
- ▶ **Operation with digital backwards counter with target time setting, adjustable from 1 minute to 99 days (Timer):** The appliance runs at the values set until the timer has elapsed. Operation in this mode is described in chapter 5.4.5.

Operation and control

5.4.4 Manual mode

In this operating mode, the appliance runs in permanent operation at the values set on the ControlCOCKPIT.

Adjustment options

As described in chapter 5.4.2, you can set the following parameters after pressing the corresponding activation key (in any sequence):

Temperature

Adjustment range: model dependent (see nameplate and technical data on page 13)

● Heating operation is indicated by the $\uparrow\uparrow\uparrow$ symbol.

i You can select °C or °F as the temperature unit displayed (see page 38).

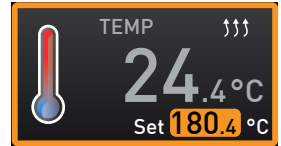

Air flap position

Adjustment range: 0 % (closed, recirculating operation) to 100 % (completely opened, fresh air operation) in steps of 10%

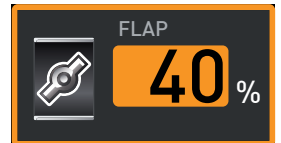

Fan speed

(only for SF appliances)

Adjustment range: 0 to 100 % in steps of 10%



5.4.5 Operation with digital backwards counter with target time setting, adjustable from 1 minute to 99 days (Timer)

In timer operation, you can adjust the time the appliance runs at the set value.

1. Press the activation key to the left of the timer display. The timer display is activated.

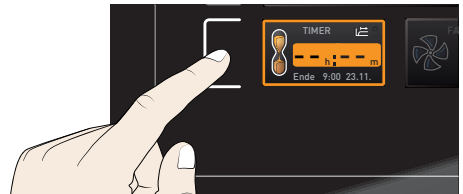

2. Turn the turn control until the desired duration is displayed – in this example 4 hours 30 minutes. The approximate end time is shown beneath, in a smaller font.



- Up to a duration of 23 hours 59 minutes, the time is displayed in hh:mm (hours:minutes) format. For 24 hours and more, the format dd:hh (days:hours) is used. The maximum duration adjustable is 99 days 00 hours.

3. Press the confirmation key.

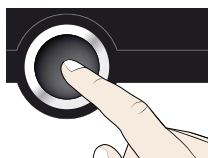

The display now shows the remaining time in a large font and the approximate end time in a smaller font beneath.



4. Now, as described under 5.4.2, set the individual values for temperature, air flap position etc. which you want the appliance to operate at. It is not possible to change any parameters while the timer is counting down.

- The timer only starts when the tolerance band of ± 3 K around the set temperature has been reached. If the temperature deviates from the tolerance band values, the timer starts again (see page 40).

When the timer has elapsed, the display shows 00h:00m. All functions (heating etc.) are switched off. If a fan had been active, it will keep on running for a short safety period. In addition, an acoustic alarm sounds, which can be turned off by pressing the confirmation key.

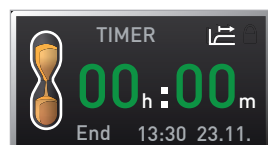

To deactivate the timer, open the timer display by pressing the activation key again and then turning the turn control to reduce the timer setting until --:-- is displayed. Confirm with the confirmation key.

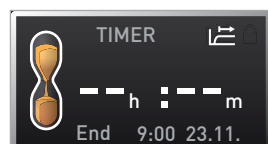

5.5 Temperature monitoring

The appliance is equipped with a double overtemperature protection (mechanical/electronic) in accordance with DIN 12 880. This serves to avoid damage to the chamber load and/or appliance in case of a malfunction:

- ▶ Electronic temperature monitoring (TWW/TWB) (TWB only if equipped with a second temperature sensor, option A6)
- ▶ mechanical temperature limiter (TB)

5.5.1 Electronic temperature monitoring

The monitoring temperature of the electronic temperature monitoring is measured via the Pt100 temperature sensor in the interior of the chamber. The type of temperature monitoring (TWW/TWB) and the monitoring temperature are set in menu mode in the Setup display (see page 39). The setting made applies to all operating modes.

If the manually set monitoring temperature is exceeded, temperature monitoring takes over temperature control and begins to regulate the monitoring temperature (TWW, Fig. 17) or switches off the heating (TWB, Fig. 18).

1 The two types of temperature monitoring are only available for appliances equipped with a second temperature sensor (option A6). For appliances with only one temperature sensor, only TWW is available.

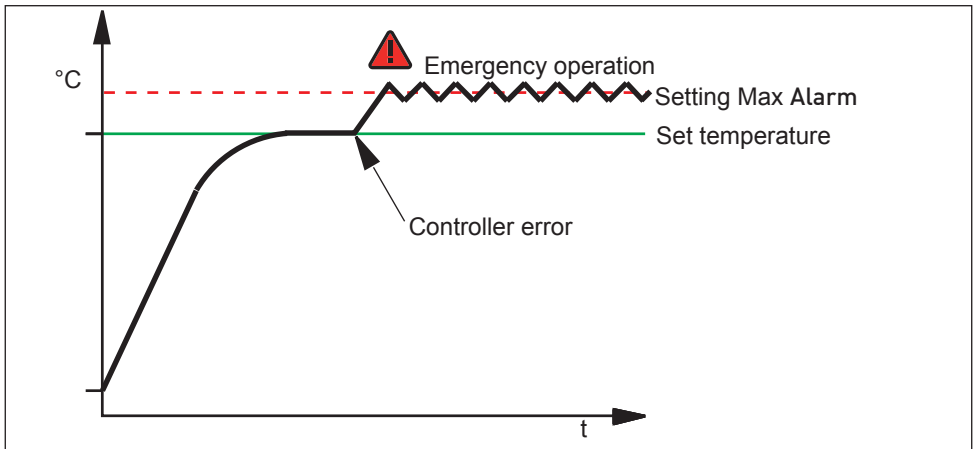

Fig. 17 Schematic diagram of how the TWW temperature monitoring system works

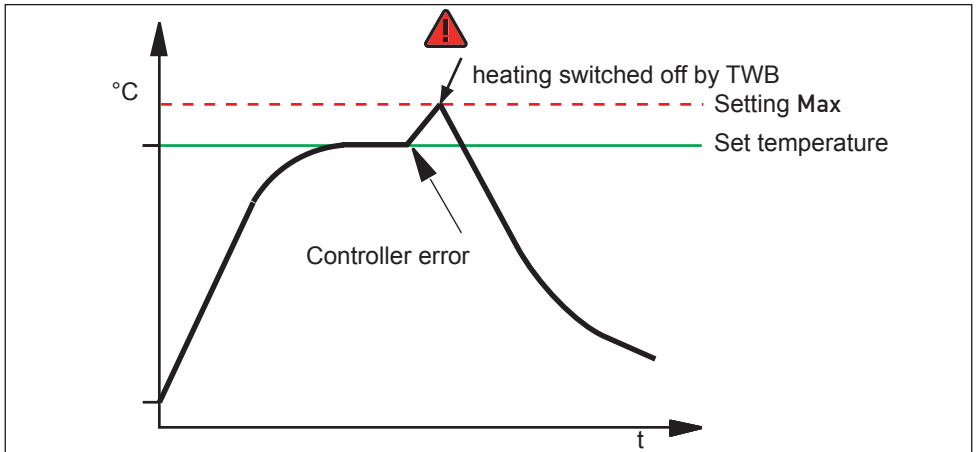



Fig. 18 Schematic diagram of how the TWB temperature monitoring works (only if equipped with a second temperature sensor, option A6)

5.5.2 Mechanical temperature monitoring: Temperature limiter (TB)

The appliance is equipped with a mechanical temperature limiter (TB) of protection class 1 in accordance with DIN 12 880.

If the electronic monitoring unit should fail during operation and the factory-set maximum temperature is exceeded by approx. 20 °C, the temperature limiter, as the final protective measure, switches off the heating permanently.

5.5.3 Function

If temperature monitoring has been triggered, this is indicated by the temperature display: the actual temperature is highlighted in red and a warning symbol  is shown (Fig. 19). The type of temperature monitoring triggered is shown beneath the temperature: TB for mechanical and TWW or TWB for electronic temperature monitoring. The alarm is additionally signalled by an intermittent acoustic signal, which can be turned off by pressing the confirmation key. Information on what to do in this case are provided in the chapter Malfunctions, warning and error messages from page 32.

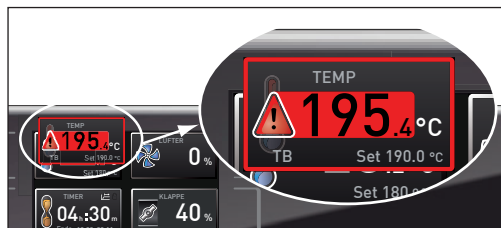

Fig. 19
Temperature monitoring triggered

5.6 Ending operation



Warning!

Depending on the operation performed, the surfaces in the working chamber and the chamber load may still be very hot after the appliance is switched off. Touching these surfaces can cause burns. Wear heat-resistant protective gloves or wait until the appliance cools down.

1. Switch off active appliance functions (turn back the set values).
2. Remove the chamber load.
3. Switch off the appliance (Fig. 20).

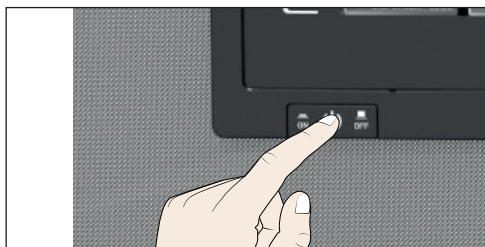

Fig. 20 Switch off appliance

6. Malfunctions, warning and error messages



Warning!

After removing covers, live parts may be exposed. You may receive an electric shock if you touch these parts. Malfunctions requiring work inside the appliance may only be rectified by electricians. Observe the separate service manual for this.

Do not try to rectify appliance errors yourself but contact the MEMMERT customer service department (see page 2) or an authorised service point.

In case of enquiries, please always specify the model and appliance number from the nameplate (see page 12).

6.1 Warning messages of the temperature monitoring function

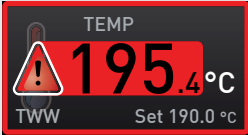
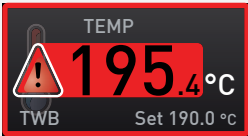
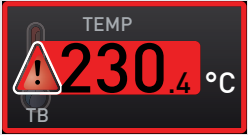
| Description | Cause | Action | See |
|--|---|---|-------------------------------|
| Temperature alarm and "TWW" are displayed  | The adjustable undertemperature / overtemperature controller (TWW) has assumed heating control. | Increase the difference between the monitoring and setpoint temperature – by either increasing the max value of the temperature monitoring (MAX temp) or decreasing the setpoint temperature. If the alarm continues: Contact customer service | page 39 page 2 |
| Temperature alarm and "TWB" are displayed  | The electronic temperature limiter (TWB) permanently switched off heating. | Deactivate the alarm by pressing the confirmation key. Increase the difference between the monitoring and setpoint temperature – by either increasing the max value of the temperature monitoring (MAX temp) or decreasing the setpoint temperature. If the alarm continues: Contact customer service | page 39 page 2 |
| Temperature alarm and TB are displayed  | The mechanical temperature limiter (TB) permanently switched off heating. | Switch off the appliance and leave to cool down. Contact customer service and have the error rectified (e.g. by replacing the temperature sensor). | page 2 |

6.2 Malfunctions, operating problems and appliance errors

| Error description | Cause of errors | Rectifying errors | See |
|--|--|--|---------|
| Displays are dark | External power supply was interrupted | Check the power supply | page 22 |
| | Miniature fuse, appliance fuse or power module faulty | Contact customer service | page 2 |
| Individual or all displays cannot be activated | The appliance is in timer or remote control mode (mode "Write" or "Write + Alarm") | Wait until the end of the timer or switch off the remote control | |
| Displays suddenly look different | Appliance is in "wrong" mode | Change to operating or menu mode by pressing the MENU key | |
| Error message E-3 in the temperature display  | Temperature sensor defective. | <ul style="list-style-type: none"> ▶ Switch off appliance. ▶ Remove the chamber load ▶ Contact customer service | page 2 |
| When switching on the appliance, the start animation is displayed in another colour than white ●●● | ▶ Cyan ●●●: Not enough storage space on the SD card | Contact customer service | page 2 |
| | ▶ Red ●●●: The system files could not be loaded | Contact customer service | page 2 |
| | ▶ Orange ●●●: The fonts and images could not be loaded | Contact customer service | page 2 |

6.3 Power failure

**Warning!**

Depending on the operation performed, the surfaces in the interior and the chamber load may still be very hot after power loss. Additionally, depending on the duration of the power loss, the appliance might heat up again after power supply has been restored (see below). Touching these surfaces can cause burns. Wear heat-resistant protective gloves or wait until the appliance cools down first.



In case of a power failure, the appliance operates as follows:

In manual mode

After power supply has been restored, operation is continued with the parameters set. The time and the duration of the power failure is documented in the protocol log memory.

In timer mode

After power supply has been restored, the timer always starts again.

7. Menu mode

In menu mode, you can make basic settings as well as adjust appliance parameters.

Caution:

i Before changing menu settings, read the description of the respective functions on the following pages to avoid possible damage to the appliance and/or chamber load.

To enter menu mode, press the MENU key.

i To exit the menu mode at any time, press the MENU key again. The appliance then returns to manual mode. Only changes accepted by pressing the confirmation key are saved.

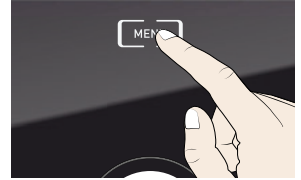

7.1 Overview

Press the MENU key to change between the displays in menu mode:

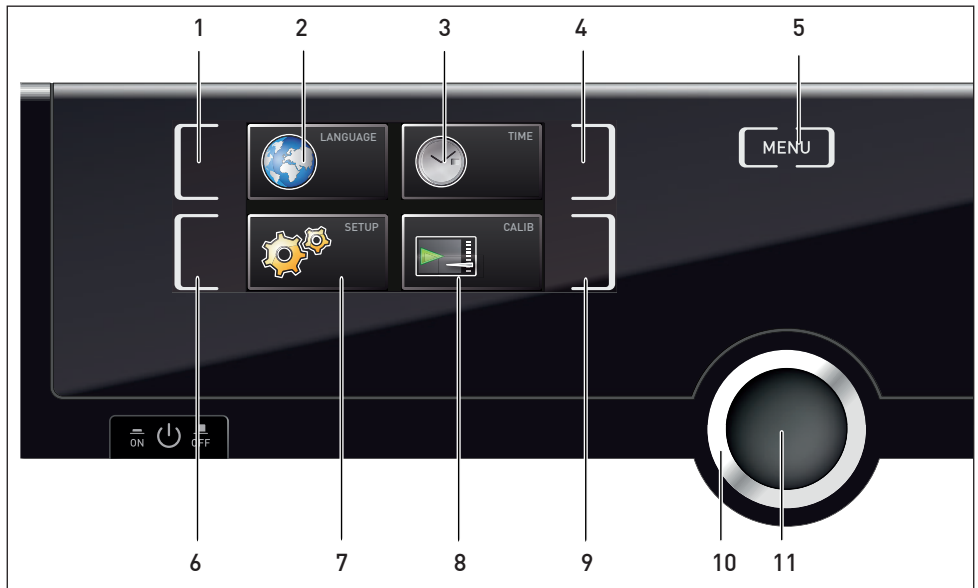

Fig. 21 ControlCOCKPIT in menu mode

- | | |
|--|---|
| <ul style="list-style-type: none"> 1 Language selection activation key 2 Language selection display 3 Date and time display 4 Date and time setting activation key 5 Return to manual mode 6 Setup activation key (basic appliance settings) | <ul style="list-style-type: none"> 7 Setup display (basic appliance settings) 8 Adjustment display 9 Adjustment activation key 10 Turn control for adjustment 11 Confirmation key (accepts setting made with the turn control) |
|--|---|

7.2 Basic operation in menu mode using the example of language selection

In general, all settings in menu mode are done just like in manual mode: Activate the respective display, use the turn control for setting and press the confirmation key to accept the change. A more detailed description is provided in the following, using the example of language selection.

1. Activate the desired parameter (in this example the language). To do so, press the corresponding activation key on the left or right of the respective display. The activated display is enlarged.

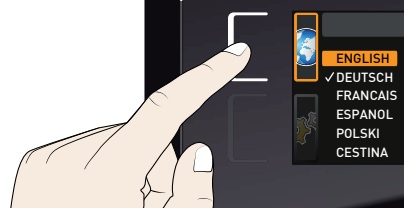

- i** If you want to exit or cancel your settings, again press the activation key which you have used to activate the display. The appliance returns to the menu overview. Only the settings that you have confirmed by pressing the confirmation key before cancelling the setting procedure are accepted.

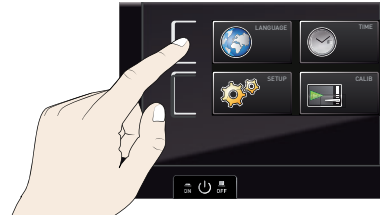

2. With the turn control, select the desired new setting, e.g. Español (Spanish).

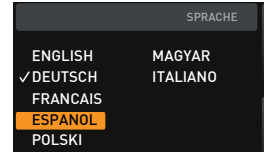

3. Save the setting by pressing the confirmation key.

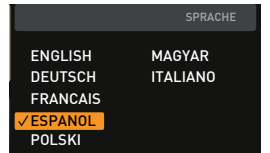
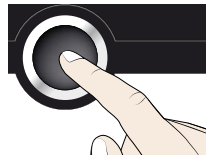

4. To return to the menu overview, press the activation key again.

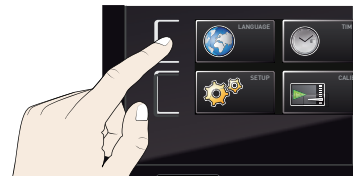

You can now

- ▶ activate another menu function by pressing the corresponding activation key or
- ▶ return to manual mode by pressing the MENU key.

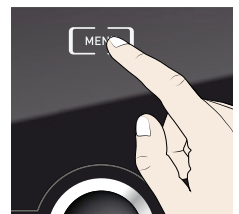

All other settings can be made accordingly. The settings possible are described in the following sections.

1 If no new values are entered or confirmed for approx. 30 seconds, the appliance automatically returns to the main menu and restores the former values.

7.3 Setup

In the SETUP display, you can set the following parameters:

- ▶ the IP address and Subnet mask of the appliance's Ethernet interface (for connection to a network)
- ▶ the Unit of the temperature display (°C or °F, see page 38)
- ▶ the type of temperature monitoring (TWW or TWB, Alarm Temp, only if equipped with a second temperature sensor, option A6) and the trigger temperature of the monitoring function (Max alarm, see page 39)
- ▶ how the digital backwards counter with target time setting works (Timer mode, see page 40)
- ▶ the type of the slide-in unit (Grid or Shelf, see page 40)
- ▶ Remote control (see page 40)
- ▶ Gateway (see page 41)

1 If the SETUP menu contains more entries than can be displayed, this is indicated by the display "1/2". This means that there is a second „page“ of entries.

To display the hidden entries, use the turn control to scroll beyond the lowest entry. The page display changes to "2/2".

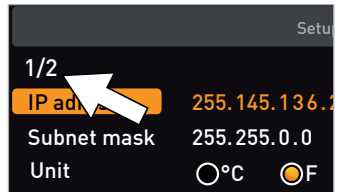

7.3.1 IP address and subnet mask

If you want to operate one or more appliances in a network, each appliance must have its own unique IP address for identification. By default, each appliance is delivered with the IP address 192.168.100.100.

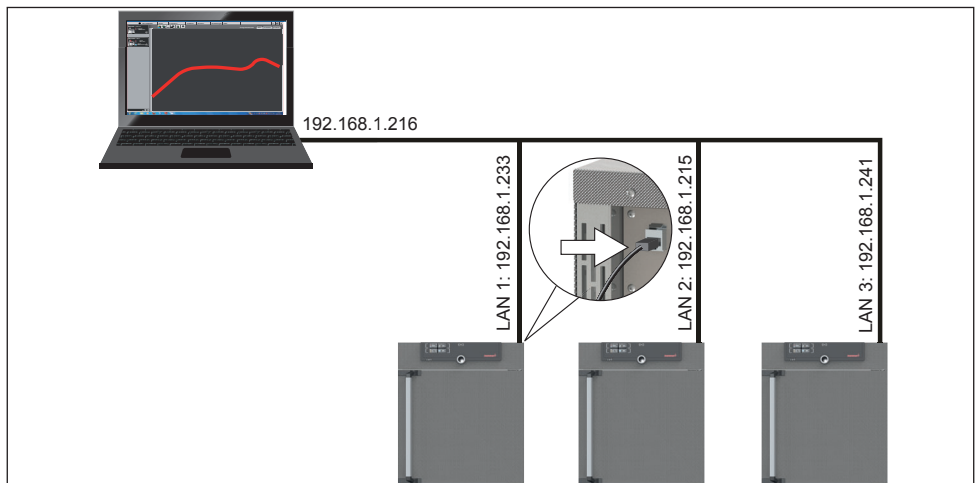
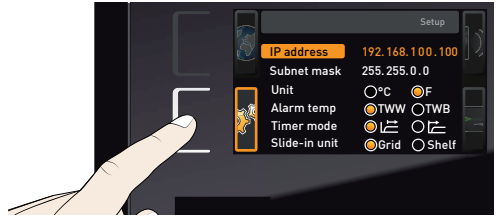
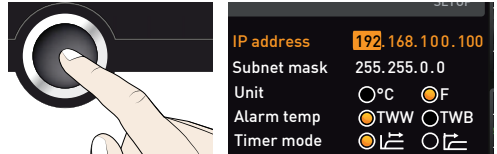

Fig. 22 Operation of several appliances in a network (schematic example)

1. Activate the SETUP display. The entry IP address is automatically highlighted.



2. Accept the selection by pressing the confirmation key. The first three digits of the IP address are automatically selected.



3. With the turn control, set the new number, e.g. 255.

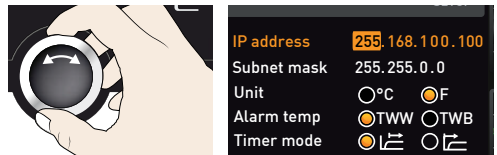

4. Accept the selection by pressing the confirmation key. The next three digits of the IP address are automatically selected. Setting these is done with the turn control according to the description above.

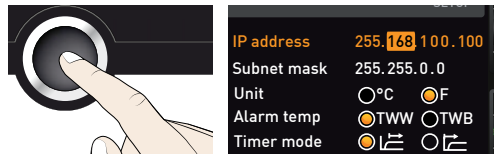

5. After setting the last three digits, accept the new IP address by pressing the confirmation key. The selection returns to the overview.

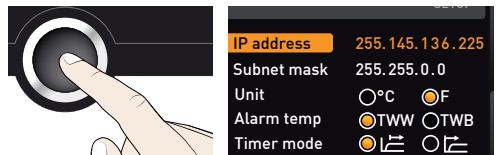

The subnet mask is set accordingly.

7.3.2 Unit

Here, you can choose whether the temperature is displayed in °C or °F.

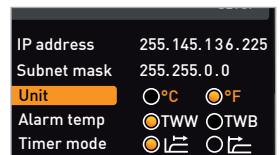

7.3.3 Temperature monitoring (Alarm Temp and Max Alarm)

Here, the type of monitoring function that should be activated (TWW or TWB, description from page 29) can be set (Alarm Temp), as well as the temperature at which the automatic temperature monitoring should be triggered (Max alarm).

- The selection option TWW/TWB is only available for appliances with a second temperature sensor (option A6).
- The monitoring temperature must be set sufficiently high above the maximum set temperature. We recommend 5 to 10 K difference.

1. Activate the SETUP display and select Alarm temp with the turn control.

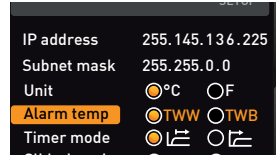

2. Accept the selection by pressing the confirmation key. The adjustment options are automatically highlighted.

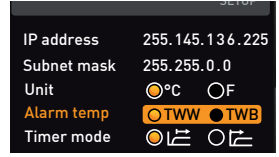
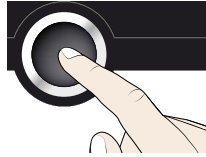

3. With the turn control, select the desired setting – in this example TWB.

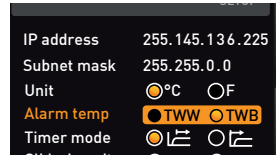

4. Save the setting by pressing the confirmation key.

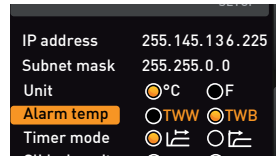
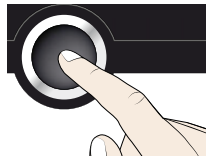

5. Select Max Alarm with the turn control.

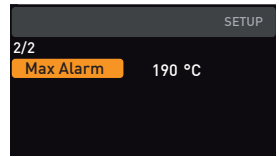

6. Accept the selection by pressing the confirmation key. The current settings are automatically highlighted.

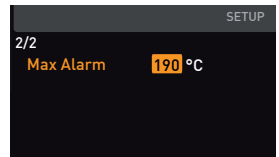
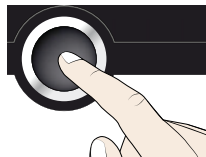

7. With the turn control, select the desired new trigger temperature - in this example 160 °C.

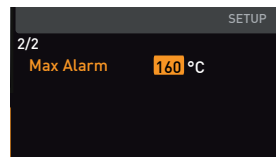

8. Save the setting by pressing the confirmation key. The electronic temperature monitoring system will now be triggered when the actual temperature reaches 160 °C.

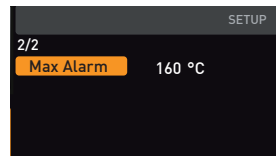
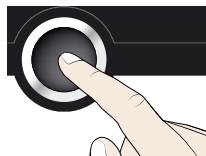

Menu mode

7.3.4 Timer Mode

By default, the timer only starts when the tolerance band of ± 3 K around the setpoint temperature has been reached (Fig. 23). To ensure that the required temperature is maintained for a sufficient period of time, this setting cannot be changed. If the temperature is no longer within the tolerance band, the sterilisation time is, for reasons of safety, restarted as soon as the required temperature is reached again.

| | | |
|-------------|-------------------------------------|--------------------------------------|
| IP address | 255.145.136.225 | |
| Subnet mask | 255.255.0.0 | |
| Unit | <input checked="" type="radio"/> °C | <input type="radio"/> °F |
| Alarm temp | <input type="radio"/> TWW | <input checked="" type="radio"/> TWB |
| Timer mode | <input checked="" type="radio"/> | <input type="radio"/> |

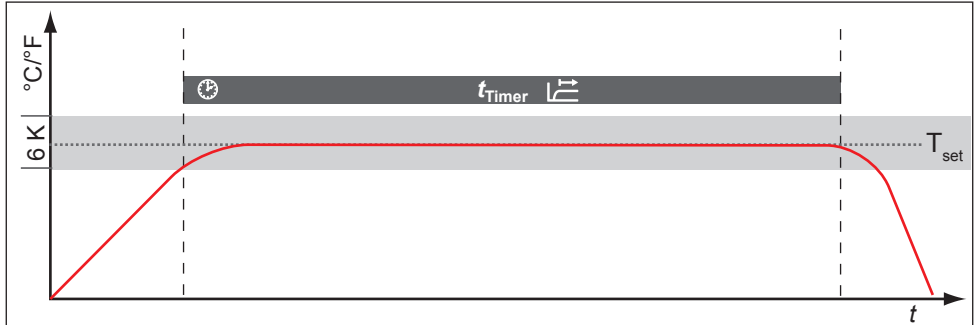

Fig. 23 Timer mode: The timer only starts when the tolerance band of ± 3 K around the set temperature has been reached

7.3.5 Type of the slide-in unit (Grid or Shelf)

Here, you have to set the type of the slide-in unit (grid or shelf) used. The selection Shelf enables you to adjust the control function to the different air flow characteristics in the interior when using optional sliding shelves instead of the grids that are part of the standard delivery.

| | | |
|------------|---------------------------------------|--------------------------------------|
| IP-Adresse | 255.145.136.225 | |
| Subnetmask | 255.255.0.0 | |
| Einheit | <input checked="" type="radio"/> °C | <input type="radio"/> °F |
| Alarm Temp | <input type="radio"/> TWW | <input checked="" type="radio"/> TWB |
| Timer mode | <input checked="" type="radio"/> | <input type="radio"/> |
| Einschub | <input checked="" type="radio"/> Rost | <input type="radio"/> Blech |

7.3.6 Remote control

In the remote control setup option, you can set whether the appliance should be controlled via remote control. These settings are available:

- ▶ Off
- ▶ Read Only

| | | |
|-----|----------------|-------------|
| 2/2 | Balance | +30 % |
| | Remote Control | Off |
| | Gateway | 192.168.5.1 |

When the appliance is in remote control mode, the symbol appears in the temperature display.

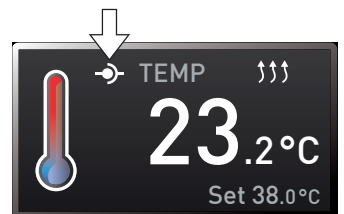

7.3.7 Gateway

The setup entry Gateway is used to connect two networks with different protocols.

The gateway is set the same way as the IP address (see page 37).

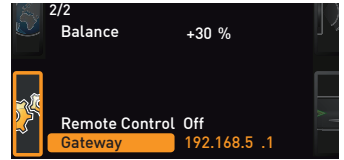

7.4 Date and Time

In the Time display, you can set date and time, time zone and daylight saving time. Changes can only be made in manual operating mode.

- Always set the time zone (and summer time yes/no) before you set the date and time.
- 1 Avoid changing the set time after that since this can lead to gaps or overlapping when recording measured values. If you still need to change the time, you should not run a programme immediately before or after doing so.

1. Activate the time setting. To do so, press the activation key on the right side of the Time display. The display is enlarged and the first adjustment option (Date) automatically highlighted.



2. Turn the turn control until Time zone is highlighted.

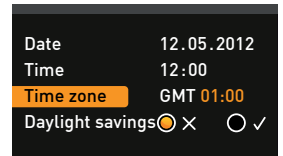

3. Accept the selection by pressing the confirmation key.

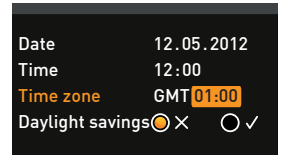
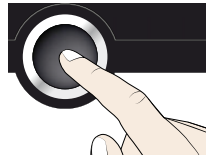

4. Set the time zone of the installation site with the turn control, e.g. 00:00 for Great Britain, 01:00 for France, Spain or Germany. Accept the selection by pressing the confirmation key.

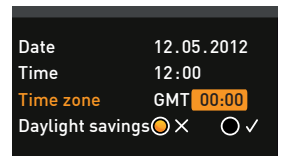

5. With the turn control, select the Daylight savings entry

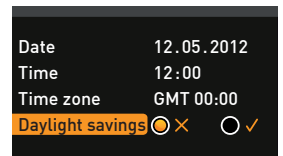

Menu mode

6. Accept the selection by pressing the confirmation key. The adjustment options are highlighted.

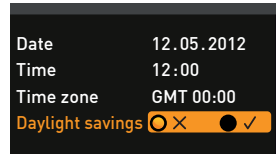
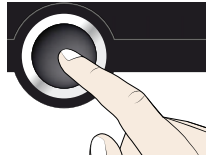

7. Set daylight savings to off (X) or on (✓) with the turn control – in this case on (✓). Save the setting by pressing the confirmation key.

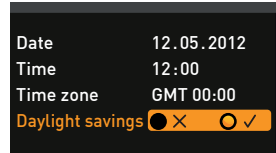

- i** Daylight saving time and standard time are not changed automatically. For this reason, please keep in mind to adjust them at the beginning of each period.

8. Now, set date (day, month year) and time (hours, minutes) in the same way. Accept the selection by pressing the confirmation key.

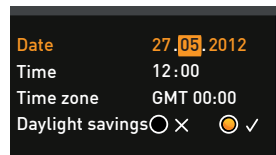

7.5 Calibration

The appliances are temperature calibrated and adjusted at the factory. In case readjustment should be necessary later on – for example due to influence of the chamber load – the appliance can be calibrated customer-specifically using three calibration temperatures of your choice:

- ▶ Cal1 Temperature calibration at low temperature
- ▶ Cal2 Temperature calibration at medium temperature
- ▶ Cal3 Temperature calibration at high temperature

To guarantee perfect control, we recommend to calibrate the appliance once a year.

- i** For temperature adjustment, you will need a calibrated reference measuring device.

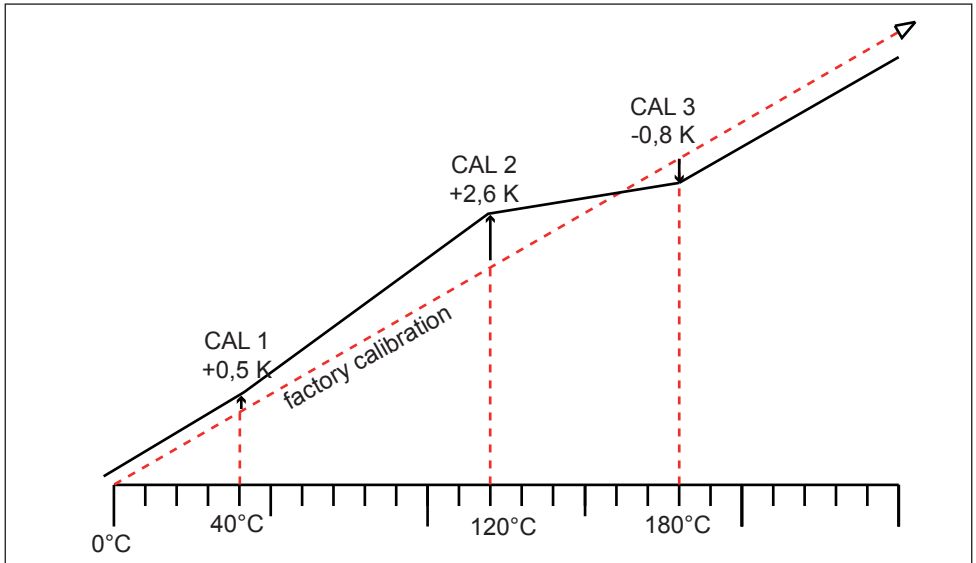
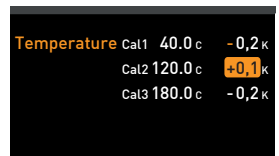
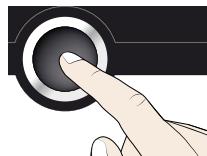
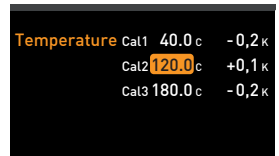
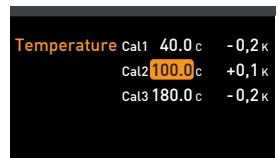
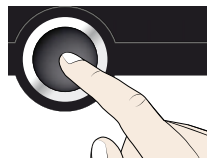
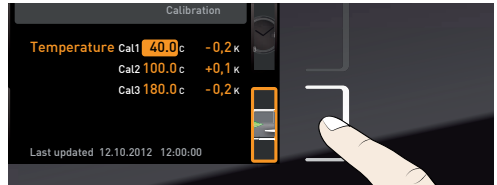

Fig. 24 Schematic example of temperature adjustment

Example: Temperature deviation at 120 °C should be corrected.

1. Activate the adjustment setting. To do so, press the activation key on the right side of the CALIB display. The display is enlarged and the first calibration temperature – in this case 40 °C – automatically highlighted.
2. Press the confirmation key repeatedly, until the calibration temperature Cal2 is selected.
3. With the turn control, set the calibration temperature Cal2 to 120 °C.
4. Save the setting by pressing the confirmation key. The corresponding calibration value is automatically highlighted.



- Set the calibration value to 0.0 K and accept the setting by pressing the confirmation key.

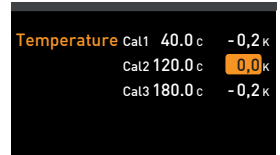

- Position the sensor of a calibrated reference instrument centrally in the appliance's working chamber.
- Close the door and, in manual mode, adjust the set temperature to 120 °C.

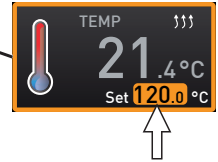
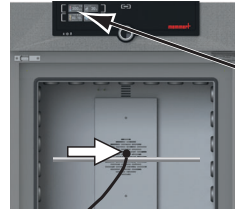

- Wait until the appliance reaches the set temperature and displays 120 °C. The reference instrument for example displays 122.6 °C.

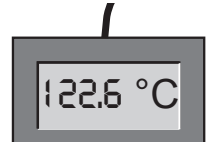
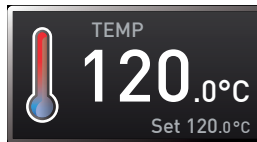

- In the SETUP, adjust the calibration value Cal2 to +2.6 K (actual value measured minus setpoint temperature) and save the setting by pressing the confirmation key.

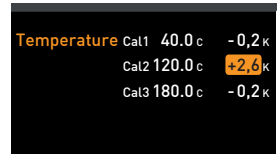

- After the calibration procedure, the temperature measured by the reference instrument should now also be 120 °C.

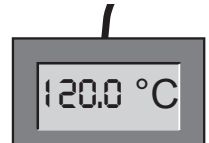
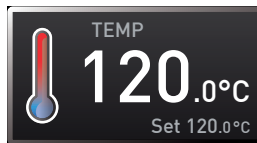

With Cal1, a calibration temperature below Cal2 can be programmed accordingly, and with Cal3, a temperature above. The minimum difference between the Cal values is 20 K.

i If all calibration values are set to 0.0 K, the factory calibration settings are restored.

8. Notes on sterilisation

8.1 Contraindications / unwanted side effects

Since hot air sterilisers don't have a direct therapeutic intended use, the aspects of contraindication and unwanted side effects are not relevant.

8.2 Note in accordance with Medical Devices Directive

The product lifetime as intended by the manufacturer is eight years.

8.3 Guidelines for sterilisation

For hot air sterilisation, there are different guidelines on the temperature and sterilisation time to choose, as well as on packaging the sterilisation load. The values to be chosen depend on the type and characteristics of the load to be sterilised and on the type of germs to be neutralised. Before beginning sterilisation, make yourself familiar with the sterilisation method laid down for your application.

Process parameters for hot air sterilisers are temperature and minimum hold time. The following process parameters have been defined in recognised standards:

- ▶ According to WHO: 180 °C with a minimum hold time of 30 min
- ▶ According to the European Pharmacopoeia: 160 °C with a minimum hold time of 120 min

For the inactivation of endotoxin (pyrogenes), dry heat of at least 180 °C can be applied. For the depletion of pyrogenic substances, you have to keep a combination of temperature and time going beyond the requirements of sterilisation.

Inactivation of endotoxin is possible using the following process parameters (data in accordance with EN ISO 20857:2013):

- ▶ 180 °C with a minimum effective time of 180 min
- ▶ 250 °C with a minimum effective time of 30 min

Caution:

i The temperature and time requirements normal for hot air sterilisation do not destroy endotoxins.

Especially when the appliance is heavily loaded, using these parameters without checking them will not be sufficient. For safe sterilisation, validation of the individual sterilisation process is required. The requirements for the validation of sterilisation by dry heat are e.g. defined in standard EN ISO 20857:2013. Also valuable is the "guideline on validation and routine monitoring of sterilisation processes using dry heat for medical products" issued by the German Society for Hospital Hygiene (DGKH).

9. Maintenance and service

9.1 Cleaning



Warning!

Danger due to electric shock. Before doing any maintenance work, pull out the mains plug.



Warning!

In case of appliances of a certain size, you can get accidentally locked in, which is life-threatening. Do not climb into the appliance!



Caution!

Danger of cuts due to sharp edges. Always wear gloves when working in the chamber interior.

9.1.1 Working chamber and metal surfaces

Regular cleaning of the easy-to-clean working chamber prevents build up of material remains that could impair the appearance and functionality of the stainless steel working chamber over time.

The metal surfaces of the appliance can be cleaned with normal stainless steel cleaning agents. Make sure that no rusty objects come into contact with the working chamber or with the stainless steel housing. Rust deposits can lead to an infection of the stainless steel. If rust spots should appear on the surface of the working chamber due to impurities, the affected area must be immediately cleaned and polished.

9.1.2 Plastic parts

Do not clean the ControlCOCKPIT and other plastic parts of the appliance with caustic or solvent-based cleaning agents.

9.1.3 Glass surfaces

Glass surfaces can be cleaned with a commercially available glass cleaner.

9.2 Regular maintenance

Once a year, grease the moving parts of the doors (hinges and lock) with thin silicone grease and check that the hinge screws are not loose.

To guarantee perfect control, we recommend to calibrate the appliance once a year (see page 42).

9.3 Repairs and service



Warning!

After removing covers, live parts may be exposed. You may receive an electric shock if you touch these parts. Disconnect the mains plug before removing any covers. Any work inside the appliance may only be performed by qualified electricians.



Repairs and service work are described in a separate service manual.

10. Storage and disposal

10.1 Storage

The appliance may only be stored under the following conditions:

- ▶ in a dry and enclosed, dust-free room
- ▶ frost-free
- ▶ disconnected from the power supply

10.2 Disposal

This product is subject to the Directive 2012/19/EC on Waste Electrical and Electronic Equipment (WEEE) of the European Parliament and of the Council. This appliance has been brought to market after August 13th, 2005 in countries which have already integrated this directive into their national laws. It may not be disposed of in normal household waste. For disposal, please contact your dealer or the manufacturer. Any appliances that are infected, infectious or contaminated with materials hazardous to health are excluded from return. Please also observe all other regulations applicable in this context.

Before disposing of the appliance, please render the door locking mechanism unusable, for example, to prevent playing children from being locked inside the appliance.

There is a lithium battery in the ControlCOCKPIT of the appliance. Remove it and dispose of it in accordance with the regulations in your country (Fig. 25).

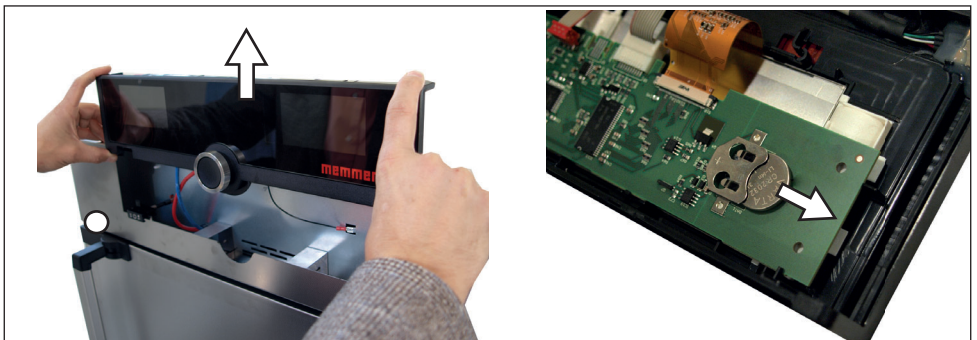
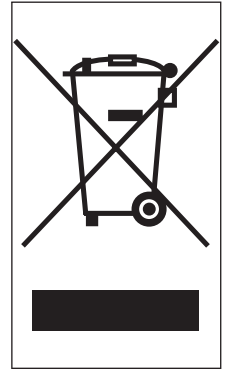

Fig. 25 Removing the lithium battery

Note for Germany:

The appliance may not be left at public or communal recycling or collection points.

Index

- A**
- Accessories 15
 - Activation key 27
 - Adjustment 42
 - Air flap position 28
 - Air supply 11
 - Alarm 38
 - Alarm temperature 39
 - Ambient conditions 14
 - Ambient temperature 14
 - Appliance error 33
 - AtmoCONTROL 3, 12, 15
- B**
- Basic device settings 35
 - Basic settings 35
- C**
- Calibration 42
 - Carrying 16
 - Cause of errors 33
 - Chamber load 25
 - Changes 8
 - Cleaning 46
 - Clock time 41
 - Communication interfaces 12
 - Compensation correction value 44
 - Connections 12
 - ControlCOCKPIT 26
 - Convection 11
 - Customer service 2
- D**
- Date and time 41
 - Declaration of conformity 14
 - Decommissioning 47
 - Delivery 16, 17, 22, 45
 - Digital backwards counter 28
 - Dimensions 14
 - Disposal 47
 - Door 24
- E**
- Electrical connection 12
 - Electrical connections 22
- Electronic temperature monitoring 30
- Emergency 9
 - Ending operation 31
 - Error description 33
 - Error messages 32
 - Explosion protection 8
- F**
- factory calibration 44
 - Fan speed 28
 - Fehlermeldung 33
 - Forklift truck 17
 - Function 11
- G**
- Gas bottles 22
 - Gateway 41
 - Graph 31
 - Grid 40
- H**
- Hazards 7
- I**
- Installation site 18
 - Intended use 8
 - Interfaces 12
 - IP address 37
- L**
- Language selection 36
 - Loading the appliance 25
 - Log memory 34
- M**
- Maintenance 46
 - Malfunctions 9, 32
 - Manufacturer 2
 - Material 11
 - Mechanical temperature monitoring 31
 - Medical Devices Directive 45
 - Menu 35, 41
 - Minimum clearances 18
- N**
- Nameplate 12
 - Network 12, 37
- Normal mode 27, 28
- O**
- Operating 24
 - Operating modes 27
 - Operating personnel 7, 24
 - Operating problems 33
 - Operation 24
- P**
- Packaging material 17
 - Power failure 34
 - Product safety 7
 - Putting into operation 22, 45
- R**
- Rectifying errors 33
 - Regular maintenance 46
 - Remote control 40
- S**
- Safety regulations 6
 - Service 46
 - Servicing 46
 - Setting parameters 27, 36
 - Setting up 16, 18
 - Setup 37
 - Shelf 40
 - Slide-in unit 40
 - Sterilisers 24, 45
 - Storage after delivery 17
 - Switching off 31
 - Switching on 23
- T**
- TB 31
 - Technical data 13
 - Temperature 28
 - Temperature comparison 42
 - Temperature deviation 43
 - Temperature limiter 31
 - Temperature monitoring 29, 38
 - Time 40
 - Timer 28
 - Timer mode 40
 - Transport 16, 17

Transport damage 17

Turn control 27

TWB 29

TWW 29

U

Unit 38

Unpacking 17

W

Warning messages 12, 32

Weight 13

EMC-Guidance

Operation Manual Appendix

Steriliser

SNxx, SFxx, SNxxplus, SFxxplus

Technical description according to EN 60601-1-2

| Guidance and manufacturer's declaration – electromagnetic emissions | | |
|---|------------|---|
| The Memmert steriliser type S.. is intended for use in the electromagnetic environment specified below. The customer or user of the steriliser type S.. should assure that it is used in such an environment. | | |
| Emissions test | Compliance | Electromagnetic environment - guidance |
| RF emissions CISPR 11 | Group 1 | The steriliser type S.. uses RF energy only for ist internal function. Therefore, ist RF emissions are very low and are not likely to cause interference in nearby electronic equipment. |
| RF emissions CISPR 11 | Class B | The sterilier type S.. is suitable for use in all establishments, including domestic establishments and those directly connected to the public low-voltage power supply network that supplies buildings used for domestic purposes. |
| Harmonic emissions IEC 61000-3-2 | Class A | |
| Volage fluctuations / flicker emissions IEC 61000-3-3 | Complies | |
| NOTE The system impedance at the interface point according to IEC 61000-3-11 should not exceed $0.248 + j0.155$ Ohm resp. $Z_{sys} = 0.29$ Ohm. | | |

| Guidance and manufacturer's declaration – electromagnetic immunity | | | |
|---|--|--|---|
| The Memmert steriliser type S.. is intended for use in the electromagnetic environment specified below. The customer or user of the steriliser type S.. should assure that it is used in such an environment. | | | |
| Immunity test | IEC 60601 test level | Compliance level | Electromagnetic enviroment – guidance |
| Electrostatic discharge (ESD) IEC 61000-4-2 | ± 6 kV contact | ± 6 kV contact | Floors should be wood, concrete or ceramic tile. If floors are covered with synthetic material, the relative humidity should be at least 30 %. |
| | ± 8 kV air | ± 8 kV air | |
| Electrical fast tranient / burst IEC 61000-4-4 | ± 2 kV for power supply lines | ± 2 kV for power supply lines | Mains power quality should be that of a typical commercial or hospital environment. |
| | ± 1 kV for input / output lines | ± 1 kV for input / output lines | |
| Surge IEC 61000-4-5 | ± 1 kV differential mode | ± 1 kV differential mode | Mains power quality should be that of a typical commercial or hospital environment. |
| | ± 2 kV common mode | ± 2 kV common mode | |
| Voltage dips, short interruptions and voltage variations on power supply input lines IEC 61000-4-11 | $< 5\% U_T$ ($>95\%$ dip in U_T) for 0,5 cycle | $< 5\% U_T$ ($>95\%$ dip in U_T) for 0,5 cycle | Mains power quality should be that of a typical commercial or hospital environment. If the user of the steriliser type S.. requires continued operation during power mains interruptions, it is recommended that the steriliser type S.. will be powered from an uninterruptible power supply. |
| | $40\% U_T$ (60 % dip in U_T) for 5 cycles | $40\% U_T$ (60 % dip in U_T) for 5 cycles | |
| | $70\% U_T$ (30 % dip in U_T) for 25 cycles | $70\% U_T$ (30 % dip in U_T) for 25 cycles | |
| Power frequency (50/60 Hz) magnetic field IEC 61000-4-8 | 3 A/m | Not applicable | |
| | | | |
| NOTE U_T is the mains voltage prior to application of the test level. | | | |

Technical description according to EN 60601-1-2

Guidance and manufacturer's declaration – electromagnetic immunity

The Memmert steriliser type S.. is intended for use in the electromagnetic environment specified below. The customer or user of the steriliser type S.. should assure that it is used in such an environment.

| Immunity test | IEC 60601 test level | Compliance level | Electromagnetic environment – guidance |
|------------------------------|-----------------------------|--------------------|---|
| | | | <p>Portable and mobile RF communications equipment should be used no closer to any part of the steriliser type S.., including cables, than the recommended separation distance calculated from the equation applicable to the frequency of the transmitter.</p> <p>Recommended separation distance</p> |
| Conducted RF | 3 V _{rms} | 3 V _{rms} | $d = 1,2 \sqrt{P}$ |
| IEC 61000-4-6 Radiated RF | 150 kHz bis 80 MHz 3 V/m | 3 V/m | $d = 1,2 \sqrt{P}$ 80 MHz to 800 MHz |
| IEC 61000-4-3 | 80 MHz bis 2,5 GHz | | $d = 2,3 \sqrt{P}$ 800 MHz to 2,5 GHz |
| | | | <p>where P is the maximum power rating of the transmitter in watts (W) according to the transmitter manufacturer and d as the recommended separation distance in metres (m).</p> <p>Field strengths from fixed RF transmitters, as determined by an electromagnetic site survey,^a should be less than the compliance level in each frequency range.^b</p> <p>Interference may occur in the vicinity of equipment marked with the following symbol:</p> |

NOTE 1 At 80 MHz and 800 MHz, the higher frequency range applies.

NOTE 2 These guidelines may not apply in all situations. Electromagnetic propagation is affected by absorption and reflection from structures, objects and people.

^a Field strengths from fixed transmitters, such as base stations for radio (cellular/cordless) telephones and land mobile radios, amateur radio, AM and FM radio broadcast and TV broadcast cannot be predicted theoretically with accuracy. To assess the electromagnetic environment due to fixed RF transmitters, an electromagnetic site survey should be considered. If the measured field strength in the location in which the steriliser type S.. is used exceeds the applicable RF compliance level above, the Steriliser type S.. should be observed to verify normal operation. If abnormal performance is observed, additional measures may be necessary, such as re-orienting or relocating the steriliser type S..

^b Over the frequency range 150 kHz to 80 MHz, field strengths should be less than 3 V/m.

Technical description according to EN 60601-1-2

| Recommended separation distances between portable and mobile RF communications equipment and the Memmert steriliser type S.. | | | |
|--|--|---|--|
| The steriliser type S.. is intended for use in electromagnetic environment in which radiated RF disturbances are controlled. The customer or of the steriliser type S.. can help prevent electromagnetic interference by maintaining a minimum distance between portable and mobile RF communications equipment (transmitters) and the steriliser type S.. as recommended below, according to the maximum power of the communications equipment. | | | |
| Rated maximum output power of transmitter W | Separation distance according to frequency of transmitter m | | |
| | 150 kHz to 80 MHz $d = 1,2 \sqrt{P}$ | 80 MHz to 800 MHz $d = 1,2 \sqrt{P}$ | 800 MHz to 2,5 GHz $d = 2,3 \sqrt{P}$ |
| 0,01 | 0,12 | 0,12 | 0,23 |
| 0,1 | 0,38 | 0,38 | 0,73 |
| 1 | 1,2 | 1,2 | 2,3 |
| 10 | 3,8 | 3,8 | 7,3 |
| 100 | 12 | 12 | 23 |
| For transmitters rated at a maximum output power not listed above, the recommended separation distance d in metres (m) can be estimated using the equation applicable to the frequency of the transmitter, where P is the maximum output power rating of the transmitter in watts (W) according to the transmitter manufacturer. | | | |
| NOTE 1 At 80 MHz and 800 MHz, the separation distance for the higher frequency range applies. | | | |
| NOTE 2 These guidelines may not apply in all situations. Electromagnetic propagation is affected by absorption and reflection from structures, objects and people. | | | |

| Listing of cables and maximum length of cables | | |
|--|---------------|------------------------------|
| Description of terminal | Type of cable | Maximum length of cable m |
| LAN port | RJ45 CAT 6 | 2 |
| Warning! The use of other cables may result in increased emissions or decreased immunity of the Memmert steriliser type S.. | | |

memmert

EC Declaration of Conformity

Manufacturer's name and address: Memmert GmbH + Co. KG
Äussere Rittersbacherstraße 38
D-91126 Schwabach
Deutschland

Authorized representative for
compiling the technical documents: Memmert GmbH + Co.KG
Technische Dokumentation (DK)
Willi-Memmert-Str. 90-96
D-91186 Büchenbach
Deutschland

Product: Sterilizer Dry Heat, Type series S
Type: SN.../30/55/75/110/160/260/450/750
SF.../30/55/75/110/160/260/450/750
SN...plus/30/55/75/110/160/260/450/750
SF...plus/ 30/55/75/110/160/260/450/750
Including all accessories

Nominal voltage: AC 230 V or 3 ~ AC 400 V 50 / 60 Hz,
alternative AC 115 V 50/60 Hz

UMDNS-Code: 13-739

Class IIb, According to directive 93/42/EEC, annex IX Rule 15 and MEDDEV
2.4/1 Rev. 9 June 2010

We hereby declare the conformity of the above mentioned products with the directive 93/42/EC
annex II, section 3. Above product is designed and manufactured in compliance with the EU directive
93/42/EC.

Notified Body TÜV Rheinland LGA Products GmbH
Tillystr. 2
D-90431 Nürnberg
Germany

Notified Body no. 0197

QS Certificate HD 60106200 0001 valid until 7. December 2020

Declaration of Conformity
Valid until 07. December 2020

The object described in the declaration above corresponds to the directive 2011/65/EC of the European
Parliament and the Council of 8 June 2011 on the restriction of the use of certain hazardous substances in
electrical and electronic equipment.

Schwabach, 10.07.2019
Legally binding signature of the issuer:



Christiane Riefler-Karpa, managing director

This declaration certifies compliance with the above mentioned directives but does not include a property assurance.
The safety note given in the product documentation which are part of the supply, must be observed.

D29603

memmert

Sterilisers

D33347 | Date 12/2019

englisch

Memmert GmbH + Co. KG
Postfach 1720 | D-91107 Schwabach
Tel. +49 9122 925-0 | Fax +49 9122 14585
E-Mail: sales@memmert.com
[facebook.com/memmert.family](https://www.facebook.com/memmert.family)