

# memmert

## IF<sub>xx</sub>bw



## OPERATING MANUAL

BLANKET WARMER

MADE IN GERMANY.

[www.memmert.com](http://www.memmert.com)

## Manufacturer and customer service

MEMMERT GmbH + Co. KG  
Willi-Memmert Strasse 90-96  
91186 Büchenbach  
Germany

Phone: +49 (0)9122 925-0  
Fax: +49 (0)9122 14585  
e-mail: [sales@memmert.com](mailto:sales@memmert.com)  
Internet: [www.memmert.com](http://www.memmert.com)

### Customer service:

Service hotline: +49 (0)9171 9792 911  
Service fax: +49 (0)9171 9792 979  
e-mail: [service@memmert.com](mailto:service@memmert.com)

When calling for service enquiries, please state the appliance number given on the name-plate (see page 11).

### Shipping address for repairs:

Memmert GmbH + Co. KG  
Customer service  
Willi-Memmert Str. 90-96  
DE-91186 Büchenbach  
Germany

Please contact our customer service department before sending appliances for repair or before returning equipment, or the shipment may be refused.

## About this manual

---

### Purpose and target audience

This manual describes the construction, function, transport and operation of IF<sub>xx</sub>bw blanket warmers. It is intended for use by trained personnel of the owner, who have the task of operating and/or maintaining the respective appliance.

If you are asked to work on the appliance, read this manual carefully before starting. Familiarise yourself with the safety regulations. Only perform work that is described in this manual. If there is something you do not understand, or certain information is missing, ask your manager or contact the manufacturer. Do not do anything without authorisation.

### Versions

The appliances are available in different configurations and sizes. If specific equipment features or functions are available only for certain configurations, this is indicated at the relevant points in this manual.

The functions described in this manual refer to the latest firmware version.

Due to individual configurations and sizes, illustrations in this manual may be slightly different from the actual appearance. Function and operation are identical.

### Other documents that have to be observed:

- ▶ For operation of the appliance with MEMMERT AtmoCONTROL, observe the separate software manual
- ▶ For service and repair work (see page 40), please refer to the separate service manual

### Storage and resale

This instruction manual belongs with the appliance and should always be stored where persons working on the appliance have access to it. It is the responsibility of the owner to ensure that persons who are working or will work on the appliance are informed as to the whereabouts of this instruction manual. We recommend that it is always stored in a protected location close to the appliance. Make sure that the instruction manual is not damaged by heat or humidity. If the appliance is resold or transported and then set up again at a different location, the operating instructions must go with it.

For the current version of this operating manual in pdf format, please go to <http://www.memmert.com/en/service/downloads/user-manual/>.

# Contents

<b>1. For your safety</b>	<b>6</b>
1.1 Terms and signs used.....	6
1.2 Product safety and dangers.....	7
1.3 Requirements of the operating personnel .....	7
1.4 Responsibility of the owner .....	8
1.5 Changes and conversions .....	8
1.6 Behaviour in case of malfunctions and irregularities .....	8
1.7 Switching off the appliance in an emergency.....	8
<b>2. Construction and description</b>	<b>9</b>
2.1 Construction.....	9
2.2 Intended use .....	10
2.3 Applied directive .....	10
2.4 Function .....	10
2.5 Material.....	10
2.6 Electrical equipment.....	10
2.7 Connections and interfaces .....	11
2.8 Designation (nameplate) .....	11
2.9 Technical data.....	12
2.10 Declaration of conformity.....	13
2.11 Ambient conditions .....	13
2.12 Scope of delivery .....	13
2.13 Optional accessories .....	13
<b>3. Delivery, transport and setting up</b>	<b>14</b>
3.1 Safety regulations.....	14
3.2 Delivery .....	15
3.3 Transport.....	15
3.4 Unpacking .....	15
3.5 Storage after delivery .....	15
3.6 Setting up .....	16
<b>4. Putting into operation</b>	<b>20</b>
4.1 Connecting the appliance.....	20
4.2 Switching on .....	20
<b>5. Operation and control</b>	<b>21</b>
5.1 Operating personnel.....	21
5.2 Opening the door.....	21
5.3 Loading the appliance.....	22
5.4 Operating the appliance.....	23
5.5 Temperature monitoring .....	26
5.6 Ending operation.....	27

---

<b>6.</b>	<b>Malfunctions, warning and error messages</b>	<b>28</b>
6.1	Warning messages of the temperature monitoring function.....	28
6.2	Malfunctions, operating problems and appliance errors .....	28
6.3	Power failure .....	29
<b>7.</b>	<b>Menu mode</b>	<b>30</b>
7.1	Overview .....	30
7.2	Basic operation in menu mode using the example of language selection.....	31
7.3	Setup.....	32
7.4	Date and time .....	36
7.5	Calibration.....	37
<b>8.</b>	<b>Maintenance and Servicing</b>	<b>40</b>
8.1	Cleaning .....	40
8.2	Regular maintenance.....	40
8.3	Repairs and Service.....	41
<b>9.</b>	<b>Storage and disposal</b>	<b>42</b>
9.1	Storage.....	42
9.2	Disposal.....	42

# 1. For your safety

## 1.1 Terms and signs used

In this manual and on the appliance itself, certain common terms and signs are used to warn you of possible dangers or to give you hints that are important in avoiding injury or damage. Observe and follow these notes and regulations to avoid accidents and damage. These terms and signs are explained below.

### 1.1.1 Terms used

**⚠ WARNING**

is used whenever you or somebody else could be injured if you do not observe the accompanying safety regulation.

**⚠ CAUTION**

is used for information that is important for avoiding damage.

### 1.1.2 Signs used

#### Warning signs (warning of a danger)



Voltage



Danger of explosion



Dangerous gases / vapours



Fire hazard



Danger of toppling over



Hazard area!  
Observe the operating instructions

#### Prohibition signs (forbidding an action)



Do not lift



Do not tilt



Do not enter

#### Regulation signs (stipulating an action)



Disconnect the mains plug



Wear gloves



Wear safety boots



Observe information in separate manual

#### Other icons



Important or useful additional information

## 1.2 Product safety and dangers

The appliances described in this manual are technically sophisticated, manufactured using high-quality materials and subject to many hours of testing in the factory. They reflect the state of the art and comply with recognised technical safety regulations. However, there are still risks involved, even when the appliances are used as intended. These are described below.



### ⚠ WARNING

Live components may be exposed once the covers have been removed. Touching these can lead to an electrical shock. Disconnect the mains plug before removing any covers. Work on the electrical system must only be performed by qualified electricians.



### ⚠ WARNING

Poisonous or explosive vapours or gases may be produced if the appliance is loaded with an unsuitable load. This could cause the appliance to explode, and people could be severely injured or poisoned. The appliance may only be loaded with blankets or cloths which do not release any toxic or explosive vapours when heated (see also chapter Intended use on page 10).



### ⚠ WARNING

Leaving the door open during operation can cause the appliance to overheat or pose a fire hazard. Do not leave the door open during operation. Cloths and blankets that are to be heated must not come in contact with the oven because they could catch fire.



### ⚠ WARNING

With appliances above a specific size, you could become accidentally locked inside, which could put you at risk of death. Do not climb into the appliance!

## 1.3 Requirements of the operating personnel

The appliance may only be operated and maintained by persons who are of legal age and have been instructed accordingly. Personnel who are to be trained, instructed or who are undergoing general training may only work with the appliance under the continuous supervision of an experienced person.

Repairs may only be performed by qualified electricians. The regulations in the separate service manual must be observed.

## 1.4 Responsibility of the owner

The owner of the appliance

- ▶ is responsible for the flawless condition of the appliance and for it being operated in accordance with its intended use (see page 10);
- ▶ is responsible for ensuring that persons who are to operate or service the appliance are qualified to do this, have been instructed accordingly and are familiar with the operating instructions at hand;
- ▶ must know about the applicable guidelines, requirements and operational safety regulations, and train staff accordingly;
- ▶ is responsible for ensuring that unauthorised persons have no access to the appliance;
- ▶ is responsible for ensuring that the maintenance plan is adhered to and that maintenance work is carried out properly (see page 40);
- ▶ has to ensure that the appliance and its surroundings are kept clean and tidy, for example through corresponding instructions and inspections;
- ▶ is responsible for ensuring that personal protective clothing is worn by operating personnel, e.g. work clothes, safety shoes and protective gloves.

## 1.5 Changes and conversions

No unauthorised changes or alterations may be made to the appliance. No parts may be added or inserted which have not been approved by the manufacturer.

Unauthorised changes or alterations result in the CE declaration of conformity losing its validity, and the appliance may no longer be operated.

The manufacturer is not liable for any damage, danger or injuries that result from unauthorised changes or alterations, or from non-compliance with the provisions in this manual.

## 1.6 Behaviour in case of malfunctions and irregularities

The appliance may only be used in a flawless condition. If you as the operator notice irregularities, malfunctions or damage, immediately take the appliance out of service and inform your superior.

**i** You can find information on troubleshooting from page 28.

## 1.7 Switching off the appliance in an emergency

Press the main switch on the ControlCOCKPIT (Fig. 1) and disconnect the power plug. This disconnects the appliance from the power supply at all poles.

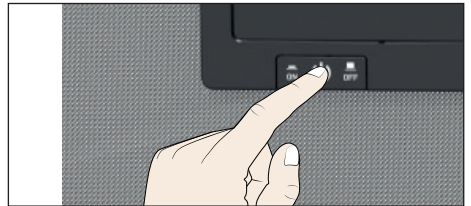

*Fig. 1  
Switch off the appliance by pressing the main switch*



## 2. Construction and description

### 2.1 Construction



Fig. 2 Construction

- 1 ControlCOCKPIT with capacitive function keys and LCD displays (see page 23)
- 2 On/Off switch (see page 20)
- 3 Chamber fan
- 4 Steel grid

- 5 Interior
- 6 Nameplate (covered, see page 11)
- 7 Door handle (see page 21)
- 8 Turn control with confirmation key

## 2.2 Intended use

The appliance is used to heat non-sterile cloths and covers. Any other use is improper and may cause damage or danger.

## 2.3 Applied directive

Based on the standards and guidelines listed in the following, the products described in this manual have received a CE label from the company Memmert:



Directive 93/42/EEC (Council Directive concerning medical devices)

## 2.4 Function

This appliance can heat the chamber up to max. 80°C. Supplied air (Fig. 3, 1) is heated in a pre-heating chamber (2). The preheated air is introduced into the chamber through the ventilation slits in the side wall of the chamber (2). A fan on the rear wall of the chamber (4) increases air flow and ensures higher horizontal forced air circulation in comparison to natural convection.

## 2.5 Material

For the outer housing, MEMMERT uses stainless steel (Mat.No. 1.4016 – ASTM 430) and for the interior, stainless steel (Mat.No. 1.4301 – ASTM 304) is used, which stands out through its high stability, optimal hygienic properties and corrosion resistance to many (but not all!) chemical compounds (caution for example with chlorine compounds).

The chamber load for the appliance must be carefully checked for chemical compatibility with the materials mentioned. A material resistance table can be requested from the manufacturer.

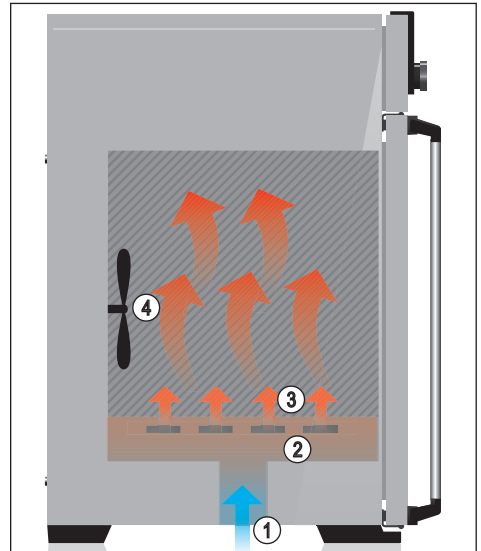

Fig. 3 Function

## 2.6 Electrical equipment

- ▶ Operating voltage and current consumption: See nameplate
- ▶ Protection class I, i.e. operating insulation with PE conductor in accordance with EN 61010
- ▶ Protection type IP 20 acc. to EN 60 529
- ▶ Interference suppression acc. to EN 55011 class B
- ▶ Appliance fuse: Safety fuse 250 V/15 A, quick-blow
- ▶ The temperature controller is protected with a miniature fuse 100 mA (160 mA at 115 V)

## 2.7 Connections and interfaces

### 2.7.1 Electrical connection

This appliance is intended for operation on an electrical power system with a system impedance  $Z_{max}$  of a maximum of 0.292 ohm at the point of transfer (service line). The operator must ensure that the appliance is operated only on an electrical power system that meets these requirements. If necessary, you can ask your local energy supply company what the system impedance is.

Observe the country-specific regulations when making connections (e.g. in Germany DIN VDE 0100 with earth leakage circuit breaker).

### 2.7.2 Communication interface

The Ethernet interface is intended for appliances which meet the requirements of IEC 60950-1. The appliance can be connected to a network to read out protocol logs with AtmoCONTROL, the optional appliance software, via Ethernet interface. The Ethernet interface is located on the rear of the appliance (Fig. 4).

For identification purposes, each appliance connected must have its own unique IP address. Configuration of the IP address is described on page 32.

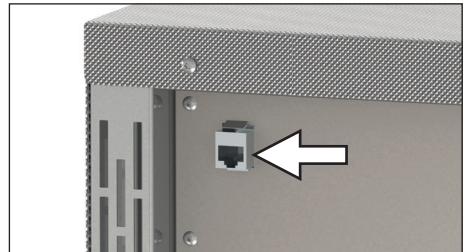

Fig. 4 Ethernet interface

The appliance can be directly connected to a computer/laptop using an optional USB to Ethernet converter (see Scope of delivery on page 13).

## 2.8 Designation (nameplate)

The nameplate (Fig. 5) provides information about the appliance model, manufacturer and technical data. It is attached to the front of the appliance, on the right beneath the door (see page 9).

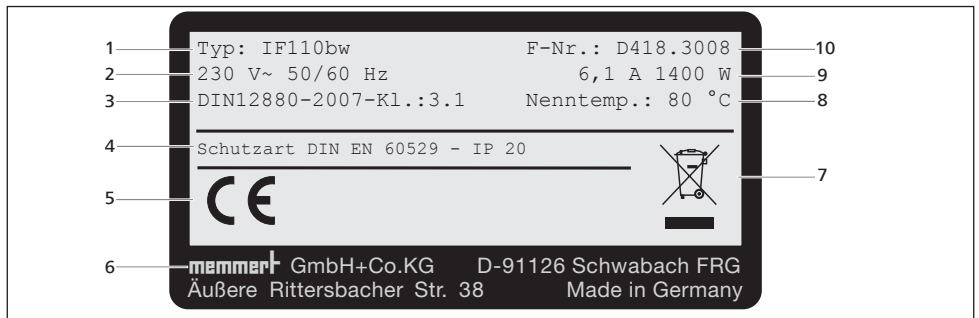

Fig. 5 Nameplate (example)

- |   |                     |    |                            |
|---|---------------------|----|----------------------------|
| 1 | Type designation    | 6  | Address of manufacturer    |
| 2 | Operating voltage   | 7  | Disposal note              |
| 3 | Applicable standard | 8  | Temperature range          |
| 4 | Protection type     | 9  | Connection / power ratings |
| 5 | CE conformity       | 10 | Appliance number           |

## 2.9 Technical data

Appliance size		110	260	450	750
Chamber width A <sup>1</sup> [mm]		560	640	1040	1040
Chamber height B <sup>1</sup> [mm]		480	800	720	1200
Chamber depth C <sup>1</sup> [mm]		400	500	600	600
Appliance width D <sup>1</sup> [mm]		745	824	1224	1224
Appliance height E <sup>1</sup> [mm]		864	1183	1247	1720
Appliance depth F <sup>1</sup> [mm]		584	684	784	784
Depth of door lock		56			
Chamber volume [litres]		108	256	449	749
Weight [kg]		78	110	170	217
Power [W]	115 V, 50/60 Hz	900	900	1500	1800
	230 V, 50/60 Hz	1400	1700	1800	2000
Current consumption [A]	230 V, 50/60 Hz	6.1	7.4	7.8	8,7
	115 V, 50/60 Hz	7.8	7.8	13.0	15.6
max. number of sliding grids		5	9	8	14
max. load per sliding grid [kg]		20		30	
max. load per appliance [kg]		175	300		
Setting temperature range		+20 to +80 °C			
Adjustment precision		0.1 K			

<sup>1</sup> see Fig. 6

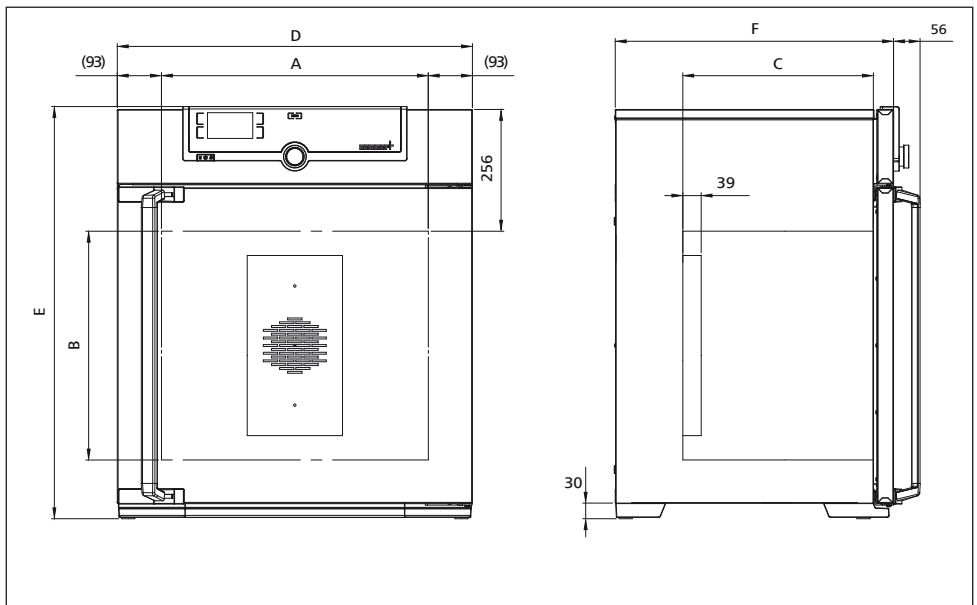

Fig. 6 Dimensions

## 2.10 Declaration of conformity

You can download the EC declaration of conformity of the appliance online:

English: <http://www.memmert.com/en/service/downloads/ce-statement/>

German: <http://www.memmert.com/de/service/downloads/eg-konformitaetserklaerung/>

## 2.11 Ambient conditions

- ▶ The appliance may only be used in enclosed areas and under the following ambient conditions:

Ambient temperature	+5 °C to +40 °C
Humidity rh	max. 80 % non-condensing
Overvoltage category	II
Pollution degree	2
Altitude of installation	max. 2,000 m above sea level

- ▶ The appliance may not be used in areas where there is a risk of explosion. The ambient air must not contain any explosive dusts, gases, vapours or gas-air mixtures. The appliance is not explosion-proof.
- ▶ Heavy dust production or aggressive vapours in the vicinity of the appliance could lead to sedimentation in the interior and, as a consequence, could result in short circuits or damage to electrical parts. For this reason, sufficient measures to prevent large clouds of dust or aggressive vapours from developing should be taken.

## 2.12 Scope of delivery

- ▶ Power cable
- ▶ Tilt protection
- ▶ One or two sliding steel grids (load capacity 30 kg each)
- ▶ the operating instructions at hand
- ▶ Calibration certificate

## 2.13 Optional accessories

- ▶ AtmoCONTROL software for reading out and processing of log data
- ▶ USB to Ethernet converter (Fig. 7). Makes it possible to connect the appliance's network interface (see page Fig. 4) to the USB port of a computer / laptop.
- ▶ Reinforced, sliding steel grids with a load capacity of 60 kg each (for appliance size 110 and larger)

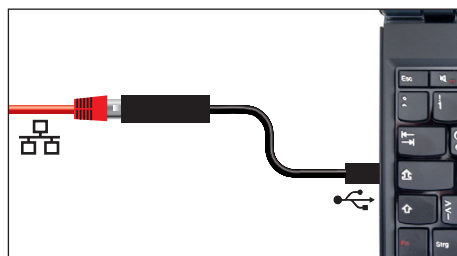

Fig. 7 USB to Ethernet converter

### 3. Delivery, transport and setting up

#### 3.1 Safety regulations



**⚠ WARNING**

There is a risk of injury due to the weight of the appliance if you try to lift it. Four people are needed to carry appliance sizes 110 and 260. Appliances larger than that may not be carried, but must be transported using a manual pallet jack or forklift truck.

110	260	450	750



**⚠ WARNING**

There is a risk of crushing injuries to the hands and feet when transporting and installing the appliance. Wear protective gloves and safety boots. Only grasp the appliance at the sides of the base:



**⚠ WARNING**

The appliance could fall over and seriously injure you. Never tilt the appliance. Only transport in upright position and without load (except standard accessories such as steel grids or shelves). Appliances with castors always have to be moved by two people.

## 3.2 Delivery

The appliance is packed in cardboard and is delivered on a wooden pallette.

## 3.3 Transport

The appliance can be transported in three ways:

- ▶ With a forklift truck; move the forks of the truck entirely under the pallet.
- ▶ On a manual pallet jack
- ▶ On its own castors, in case of the corresponding configuration, for which the catch on the (front) castors must be released

## 3.4 Unpacking

**i** To avoid damage, do not unpack the appliance until you reach the installation site.

Remove the cardboard packaging by pulling it upwards or carefully cutting along an edge.

### 3.4.1 Checking for completeness and transport damage

- ▶ Check the delivery note to ensure that the delivery is complete.
- ▶ Check the appliance for damage.

If you notice deviations from the delivery note, damage or irregularities, do not put the appliance into operation but inform the haulage company and the manufacturer.

### 3.4.2 Removing the transportation lock

Remove the transportation lock. This is located between the door hinge, door and frame and can be removed after opening the door.

### 3.4.3 Disposing of packaging material

Dispose of the packaging material (cardboard, wood, foil) in accordance with the applicable disposal regulations for the respective material in your country.

## 3.5 Storage after delivery

If the appliance is first to be stored after delivery: Read the storage conditions from page 42.

## 3.6 Setting up



### ⚠ WARNING

Due to its centre of gravity, the appliance may fall over forwards and injure you or other people. Always attach the appliance to a wall using the tilt protection provided (see page 18). In case there is not enough space, do not put the appliance into operation and do not open the door. Contact the Memmert service (see page 2).

### 3.6.1 Preconditions

The installation site must be flat and horizontal and must be able to reliably bear the weight of the appliance (see "Technical data" on page 12). Do not place the appliance on a flammable surface.

Depending on the model (see nameplate), a 230 V, 115 V or 400 V power connection must be available at the installation site.

The distance between the wall and the rear of the appliance must be at least 15 cm. The clearance from the ceiling must not be less than 20 cm and the side clearance from walls or nearby appliances must not be less than 5 cm (Fig. 8). Sufficient air circulation in the vicinity of the appliance must be guaranteed at all times.

For appliances with castors, these need to be positioned in forward direction at all times.

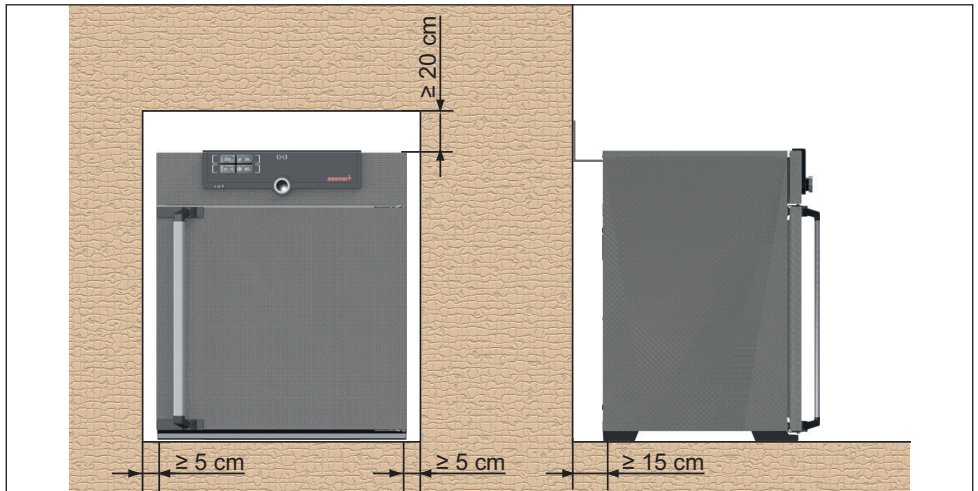









Fig. 8 Minimum clearance from walls and ceiling



## 3.6.2 Installation options

Setting up	Comments	Suitable for appliance size ...			
		110	260	450	750
Bottom 		✓	✓	✓	✓
Table 	Check the load capacity first	✓	✗	✗	✗
Stacked 	two appliances maximum; mounting material (feet) provided	✓	✗	✗	✗
Wall mounting 	Separately packaged fastening material is included in the scope of delivery. Observe the assembly instructions provided.	✓	✗	✗	✗
Base 	with/without castors	✓	✓	✓	✗
Castor frame 		✓	✓	✗	✗
Height adjustable feet 		✓	✓	✓	✓

### 3.6.3 Tilt protection

Attach the appliance to a wall with the tilt protection. The tilt protection is included in the delivery.

1. Screw the tilt protection onto the back of the appliance as illustrated.
2. Bend the tilt protection upwards by 90° in the desired distance to the wall (observe the minimum distance to the wall, see Fig. 8).
3. Drill a hole, insert a dowel and screw the tilt protection to a suitable wall.

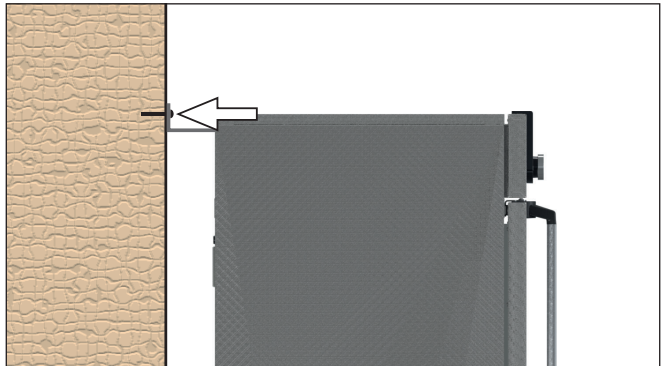
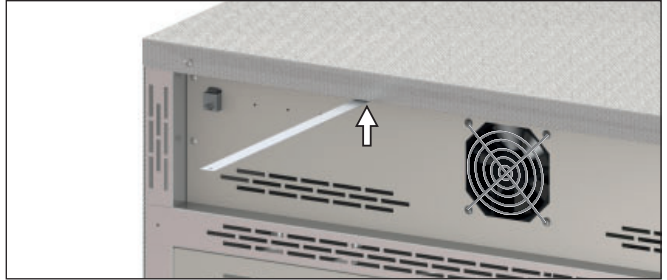

### 3.6.4 Adjusting the doors

You can adjust the doors for appliances if necessary, for example if they are warped due to uneven flooring. There are two adjusting screws each at the top and the bottom of each door for this purpose (Fig. 9).

1 First, adjust the setting at the top of the door and, if this is not sufficient, adjust the screws **1** at the bottom of the door.

1. Open the door.
2. Loosen the screws.
3. Adjust the position of the door.
4. Tighten the screws again.
5. Check the position of the door.
6. Readjust if required.

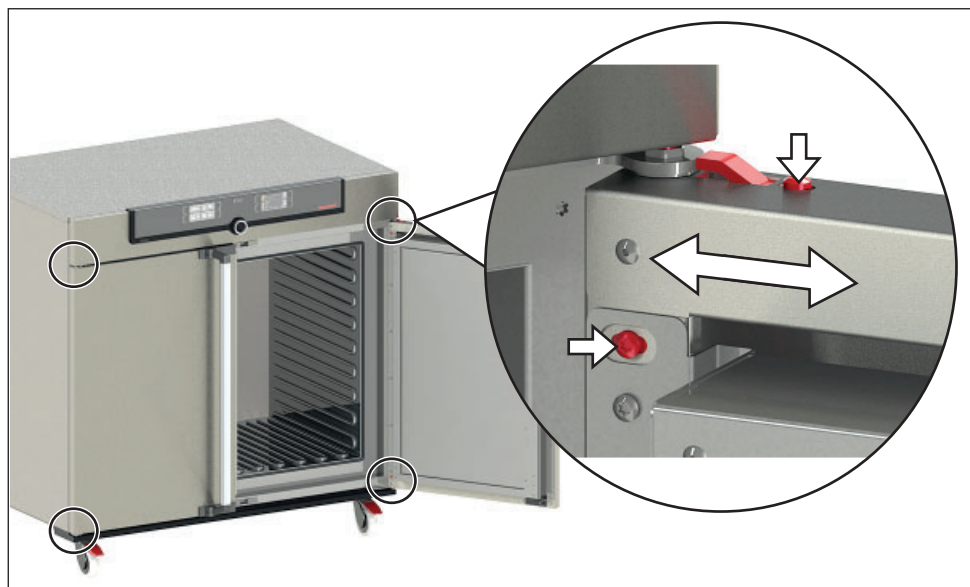

Fig. 9 Adjusting the doors

## 4. Putting into operation

### ● Caution:

**i** When operating the appliance for the first time, do not leave it unattended until it has reached a steady state.

### 4.1 Connecting the appliance

#### ● Caution:

**i** Observe the country-specific regulations when making connections (e.g. DIN VDE 0100 with earth leakage circuit breaker, in Germany). Observe the connection and power ratings (see nameplate and "Technical Data" on page 12). Make sure to establish a safe PE conductor connection.

Place the power cable so that

- ▶ it is easily accessible at all times and can be pulled off quickly, for example in case of interference or an emergency;
- ▶ it does not represent a trip hazard;
- ▶ it cannot come into contact with any hot parts.

Plug the provided power cable into the rear of the appliance and connect it to a CEE 7/4 socket. (Fig. 10).

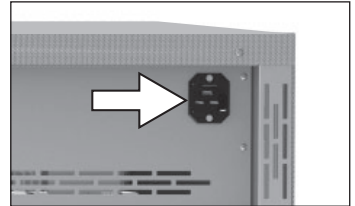

Fig. 10 Power connection  
230/115 V

### 4.2 Switching on

Switch the appliance on by pressing the main switch on the front of the appliance (Fig. 11).

The start-up process is shown by three animated white dots **●●●**. If the dots are any other colour, an error has occurred (see page 29).

**i** The appliance displays are in English by default when the appliance is switched on for the first time. You can change the language as described from page 31 . However, to get a basic overview of operating the appliance, you should read the following chapter first.

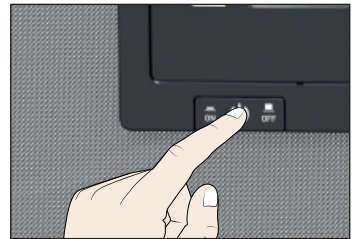

Fig. 11 Switching on the appliance

## 5. Operation and control

### 5.1 Operating personnel

The appliance may only be operated by persons who are of legal age and have been instructed accordingly. Personnel who are to be trained, instructed or who are undergoing general training may only work with the appliance under the continuous supervision of an experienced person.

### 5.2 Opening the door

- ▶ To open the door, pull the door handle sideways (to the left or to the right, depending on the door version, see Fig. Fig. 12, A) and open the door wide.
- ▶ To close the appliance, push the door closed and push the door handle sideways (B).

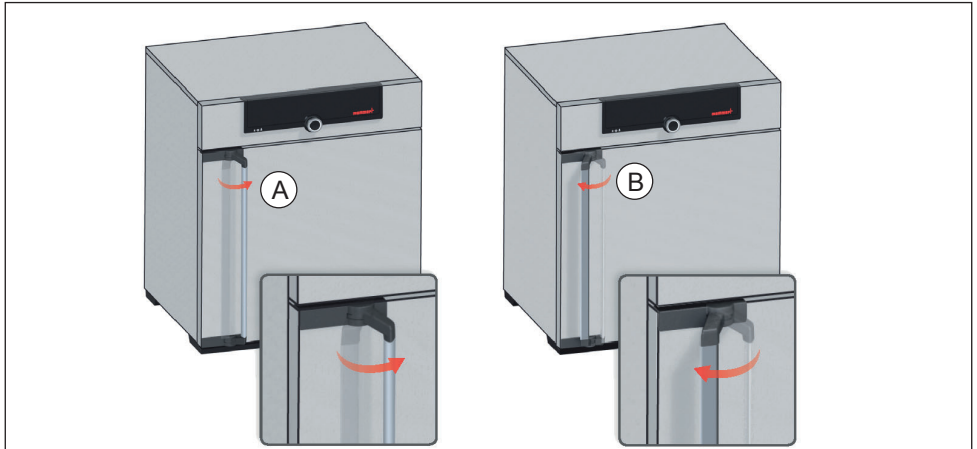

Fig. 12 Opening and closing the door



#### ⚠ WARNING

Leaving the door open during operation can cause the appliance to overheat or pose a fire hazard. Do not leave the door open during operation.



#### ⚠ WARNING

With appliances above a specific size, you could become accidentally locked inside, which could put you at risk of death. Do not climb into the appliance!

**i** If the door stays open for a certain amount of time during operation, an alarm will sound. It can be stopped by pressing the confirmation key.

### 5.3 Loading the appliance



**⚠ WARNING**

When loading the appliance with an unsuitable load, poisonous or explosive vapours or gases may be produced. This could cause the appliance to explode, and people could be severely injured or poisoned. The appliance may only be loaded with cloths and blankets that do not release any poisonous or explosive vapours when heated. If there is any doubt as to the composition of materials, they must not be loaded into the appliance.



**⚠ WARNING**

Cloths and blankets must never touch the oven, they could catch fire. Maintain a clearance of 2 cm around the surfaces.

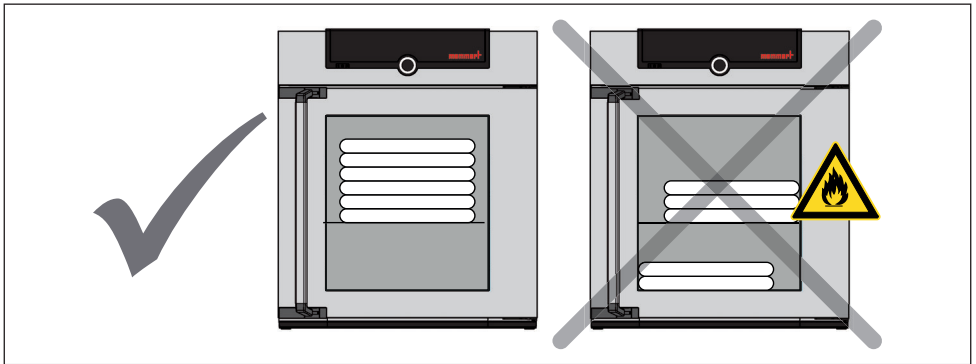

Fig. 13 Correct placement of cloths and blankets at least 2 cm away from the surfaces

Insert the sliding steel grids or sliding shelves. The maximum number of grids/shelves and the load capacity are specified in the technical data overview from page 12.

The chamber must not be loaded too tightly, so that proper air circulation in the interior is guaranteed. Do not place any of the chamber load on the bottom, touching the side walls or right below the ceiling of the chamber (Fig. 13, see also the "correct loading" sticker on the appliance).

In case of improper loading (not enough space between the items), the set temperature may be exceeded or it may take longer until it is reached.

- i** To achieve the correct heating capacity, the type of slide-in unit used – grid or shelf – must be set in the menu under **SETUP** (see page 35).

## 5.4 Operating the appliance

### 5.4.1 ControlCOCKPIT

In manual mode, the desired parameters are entered in the ControlCOCKPIT on the front of the appliance (Fig. 14). You can also make basic settings here (menu mode). Additionally, warning messages are displayed, e.g. if the temperature is exceeded.

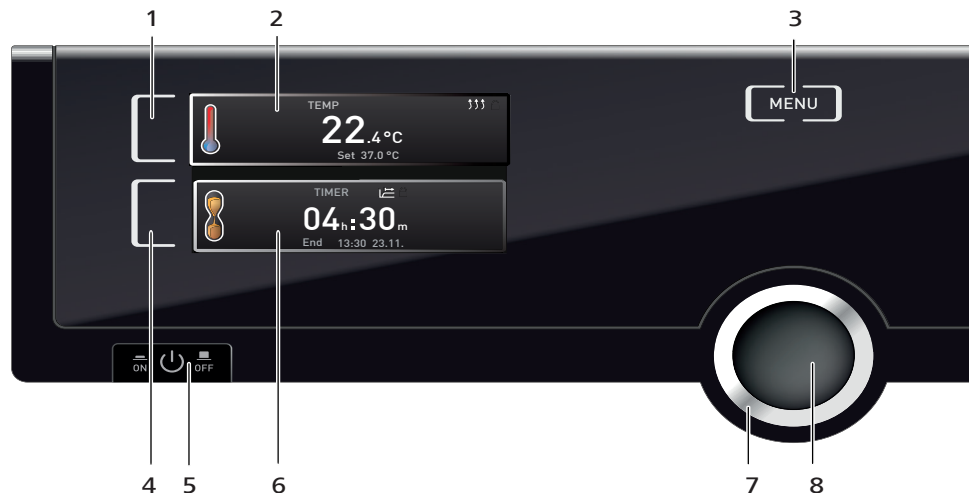

Fig. 14 ControlCOCKPIT in operating mode

- |  |   |
|--|---|
| <p>1 Activation key for temperature setpoint adjustment</p> <p>2 Setpoint and actual temperature display</p> <p>3 Switch to menu mode (see page 30)</p> <p>4 Activation key digital backwards counter with target time setting, adjustable from 1 minute to 99 days</p> <p>5 On/Off switch</p> | <p>6 Display digital backwards counter with target time setting, adjustable from 1 minute to 99 days</p> <p>7 Turn control for setpoint adjustment</p> <p>8 Confirmation key (accepts setting made with the turn control)</p> |
|--|---|

### 5.4.2 Basic operation

In general, all settings are made according to the following pattern:

1. Activate the desired parameter (e.g. temperature). To do so, press the corresponding activation key on the left or right or the respective display. The activated display is lined in colour, the other displays are dimmed. The set value (Set) is highlighted in colour.
2. By turning the turn control to the left or right, adjust the set value (e.g. to 37.0 °C).

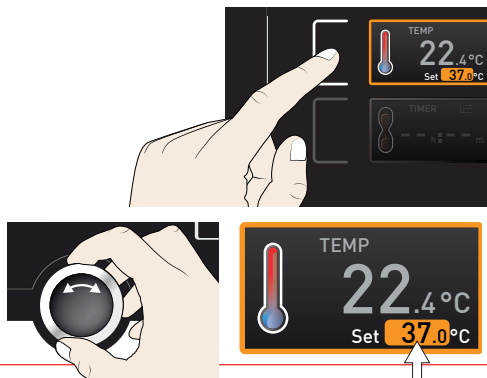

- Save the set value by pressing the confirmation key.  
The display returns to normal and the appliance begins adjusting to the defined set value.

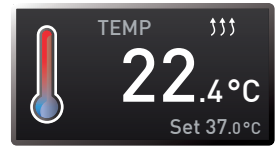
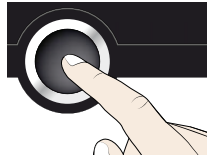

Additional parameters can be set accordingly.

- If no new values are entered or confirmed for approx. 30 seconds, the appliance automatically restores the former values.

If you want to abort the setting procedure, press the activation key on the left or right of the display that you want to exit. The appliance restores the former values. Only the settings that you have confirmed by pressing the confirmation key before cancelling the setting procedure are accepted.

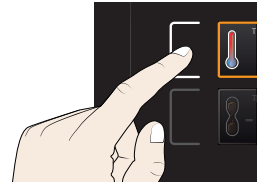

### 5.4.3 Operating modes

The appliance can be operated in different modes:

- ▶ **Manual mode:** The appliance runs in permanent operation at the values set on the ControlCOCKPIT. Operation in this mode is described in chapter 5.4.4.
- ▶ **Operation with digital backwards counter with target time setting, adjustable from 1 minute to 99 days (timer):** The appliance will run at the values set until the set time has elapsed. Operation in this mode is described in chapter 5.4.5.
- ▶ **By remote control** (see page 35)

### 5.4.4 Manual mode

In this operating mode, the appliance runs in permanent operation at the values set on the ControlCOCKPIT.

#### Adjustment options

As described in chapter 5.4.2, you can set the following parameters after pressing the corresponding activation key (in any sequence):

#### Temperature

Adjustment range: model-dependent (see nameplate and technical data on page 12)

- Heating operation is indicated by the  $\uparrow\uparrow\uparrow$  symbol.
- You can select  $^{\circ}\text{C}$  or  $^{\circ}\text{F}$  as the temperature units displayed (see page 33).

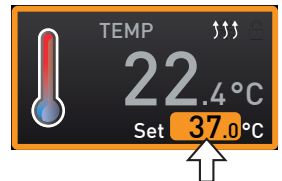



### 5.4.5 Operation with digital backwards counter with target time setting, adjustable from 1 minute to 99 days (timer)

In timer operation, you can adjust the time the appliance runs at the set values.

1. Press the activation key to the left of the timer display. The timer display is activated.

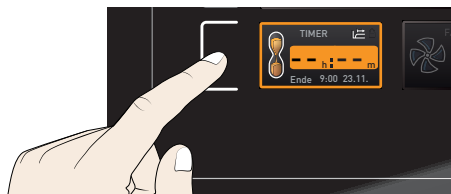

2. Turn the turn control until the desired duration is displayed – in this example 4 hours 30 minutes. The approximate end time is shown beneath, in a smaller font.



- i** Up to a duration of 23 hours 59 minutes, the time is displayed in hh:mm (hours:minutes) format. For 24 hours and more, the format dd:hh (days:hours) is used. The maximum duration adjustable is 99 days 00 hours.

3. Press the confirmation key.

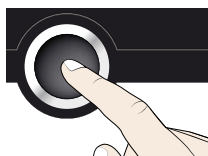

The display now shows the remaining time in a large font and the approximate end time in a smaller font.

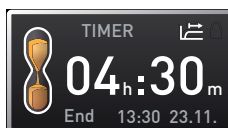

4. Now, as described under 5.4.2, set the individual values for temperature, air flap position etc. which you want the appliance to operate at. The set values can be changed at any time. The changes are effective immediately.

- i** In Setup, you can choose if the timer should be setpoint-dependent or not. This determines whether the timer should not start until a tolerance band around the set temperature is reached or if it should start immediately after activation (see page 34). The  symbol on the timer display indicates that the timer is set to setpoint-dependent.

Once the timer has finished, the display shows 00h:00m. All functions (heating etc.) are switched off. If a fan was on, it will continue running for a short safety period. In addition, an acoustic alarm sounds, which can be turned off by pressing the confirmation key.

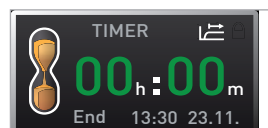

To deactivate the timer, open the timer display by pressing the activation key again and then turning the turn control to reduce the timer setting until --:-- is displayed. Press the confirmation key to confirm.

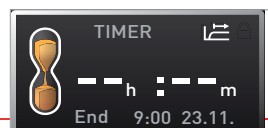

## 5.5 Temperature monitoring

The appliance is equipped with a double overtemperature protection (mechanical/electronic) in accordance with DIN 12 880. This serves to avoid damage to the chamber load and/or appliance in case of a malfunction:

- ▶ electronic temperature monitoring (TWW)
- ▶ mechanical temperature limiter (TB)

### 5.5.1 Electronic temperature monitoring

The monitoring temperature of the electronic temperature monitoring is measured via a separate PT100 temperature sensor in the chamber. Two additional temperature sensors measure the temperature of the interior surface. In menu mode, the trigger temperature is set on the Setup screen (see page 34). The setting made applies to all operating modes.

If the manually set monitoring temperature is exceeded, temperature monitoring takes over temperature control and begins to regulate the monitoring temperature (TWW, Fig. 15).

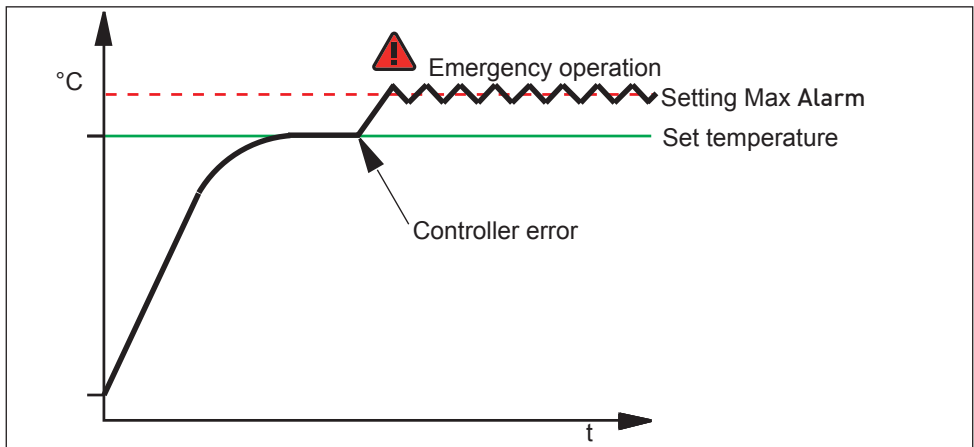



Fig. 15 Schematic diagram of how the TWW electronic temperature monitoring system works

### 5.5.2 Mechanical temperature monitoring: Temperature limiter (TB)

The appliance is equipped with a mechanical temperature limiter (TB) of protection class 1 in accordance with DIN 12 880.

If the electronic monitoring unit should fail during operation and the factory-set maximum temperature is exceeded by approx. 20 °C, the temperature limiter, as the final protective measure, switches off the heating permanently.

### 5.5.3 Function

If temperature monitoring has been triggered, this is indicated on the temperature display: the actual temperature is highlighted in red and a  warning symbol is shown (Fig. 16). The type of temperature monitoring triggered is shown under the temperature. TB for mechanical and TWW for electronic temperature monitoring. The alarm is additionally signalled by an intermittent acoustic signal, which can be turned off by pressing the confirmation key. Information on what to do if this happens can be found in chapter Malfunctions, warning and error messages from page 28.

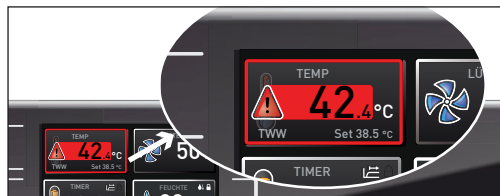

Fig. 16  
Temperature monitoring triggered

## 5.6 Ending operation

1. Switch off active appliance functions (turn back the set values).
2. Remove the chamber load.
3. Switch off the appliance with the main switch (Fig. 17).

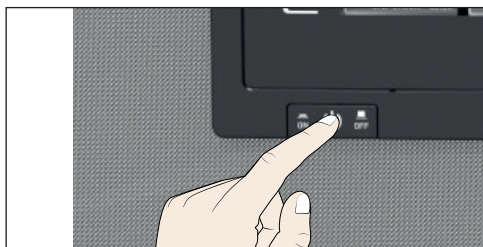

Fig. 17 Switching off the appliance.

## 6. Malfunctions, warning and error messages



### ⚠ WARNING

After removing covers, live parts may be exposed. Touching these can lead to an electrical shock. Malfunctions requiring work inside the appliance may only be rectified by electricians. Observe the separate service manual for this.

Do not try to rectify appliance errors yourself but contact the MEMMERT customer service department (see page 2) or an authorised service point.



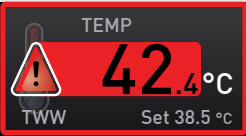
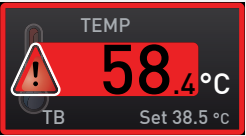

In case of enquiries, please always specify the model and appliance number given on the nameplate (see page 11).

### 6.1 Warning messages of the temperature monitoring function

Description	Cause	Action	See
Temperature alarm and "TWW" are displayed 	The adjustable temperature controller (TWW) has assumed heating control.	Increase the difference between the monitoring and setpoint temperature – by either increasing the max value of the temperature monitoring or decreasing the setpoint temperature.  If the alarm continues: Contact customer service	Page 34          Page 2
Temperature alarm and TB are displayed 	The mechanical temperature limiter (TB) permanently switched off heating.	Switch off the appliance and leave to cool down. Contact customer service and have the error rectified (e.g. by replacing the temperature sensor).	Page 2

### 6.2 Malfunctions, operating problems and appliance errors

Error description	Cause of errors	Rectifying errors	See
Displays are dark	External power supply was interrupted	Check the power supply	Page 20
	Miniature fuse, appliance fuse or power module faulty	Contact customer service	Page 2

Error description	Cause of errors	Rectifying errors	See
Individual or all displays cannot be activated	The appliance is operating with backwards counter and target time setting (timer) or is in remote control mode	Wait for the timer to finish or switch off timer/remote control	
Displays suddenly look different	Appliance is in "wrong" mode	Change to operating or menu mode by pressing the MENU key	
Error message E-3 in the temperature display 	Temperature sensor faulty	<ul style="list-style-type: none"> <li>▶ Switch off appliance</li> <li>▶ Remove the chamber load</li> <li>▶ Contact customer service</li> </ul>	Page 2
When switching on the appliance, the start animation is displayed in another colour than white 	<ul style="list-style-type: none"> <li>▶ Cyan : Not enough storage space on the SD card</li> <li>▶ Red : The system files could not be loaded</li> <li>▶ Orange : The fonts and images could not be loaded</li> </ul>	Contact customer service  Contact customer service  Contact customer service	Page 2  Page 2  Page 2

### 6.3 Power failure

In case of a power failure, the appliance operates as follows:

#### In manual mode

After power supply has been restored, operation is continued with the parameters set. The time and duration of the power failure are documented in the log memory.

#### Operating with backwards counter and target time setting (timer)

In case of an interruption of the power supply of less than 60 minutes, the current timer is continued from the point at which it was interrupted. For interruptions of the power supply longer than this, all appliance functions (heating, fan etc.) are switched off and the air flap is opened.

#### In remote control mode

The previous values are restored.

## 7. Menu mode

In menu mode, you can make basic settings as well as adjust appliance parameters.

### Caution:

Before changing menu settings, read the description of the respective functions on the following pages to avoid possible damage to the appliance and/or chamber load.

To enter menu mode, press the MENU key.

To exit the menu mode at any time, press the MENU key again. The appliance then returns to operating mode. Only changes accepted by pressing the confirmation key are saved.

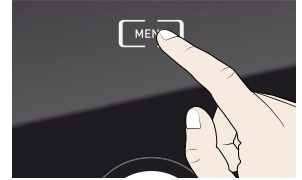

### 7.1 Overview

Press the MENU key to change between the displays in menu mode:

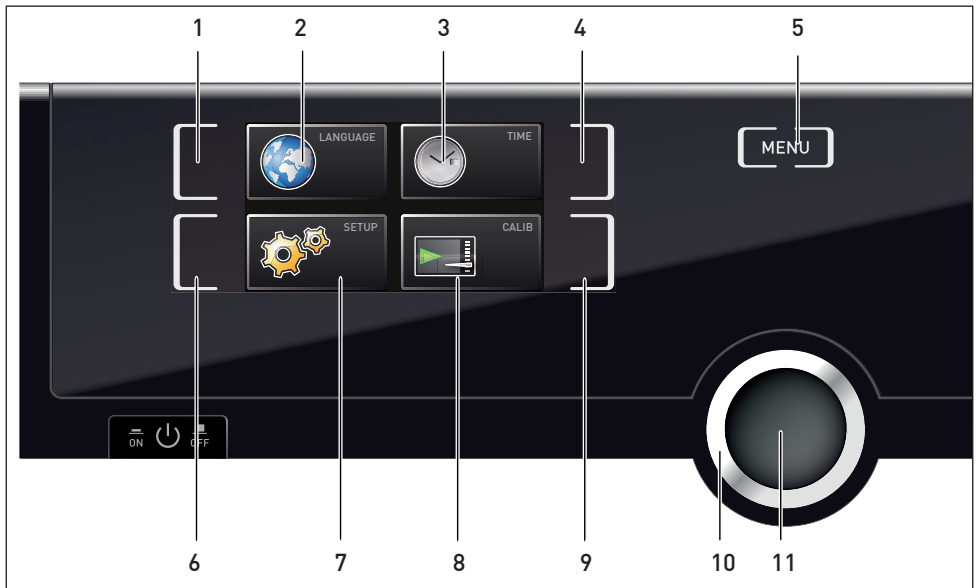

Fig. 18 ControlCOCKPIT in menu mode

- |   |  |
|---|--|
| 1 Language selection activation key               | 7 Setup display (basic appliance settings)                       |
| 2 Language selection display                      | 8 Adjustment display   |
| 3 Date and time display                           | 9 Adjustment activation key                                      |
| 4 Date and time setting activation key            | 10 Turn control for adjustment                                   |
| 5 Return to operating mode                        | 11 Confirmation key (accepts setting made with the turn control) |
| 6 Setup activation key (basic appliance settings) |  |

## 7.2 Basic operation in menu mode using the example of language selection

In general, all settings in menu mode are done just like in operating mode: Activate the respective display, use the turn control for setting and press the confirmation key to accept the change. A more detailed description is provided in the following, using the example of language selection.

1. Activate the desired parameter (in this example the language). To do so, press the corresponding activation key on the left or right of the respective display. The activated display is enlarged.

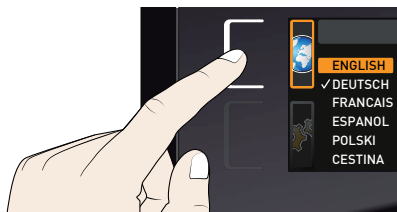

- i** If you want to exit or cancel the settings, again press the activation key which you have used to activate the display. The appliance returns to the menu overview. Only the settings that you have confirmed by pressing the confirmation key before cancelling the setting procedure are accepted.

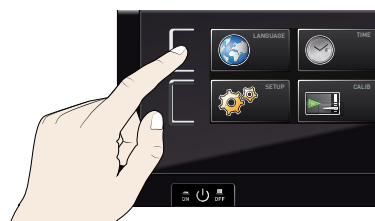

2. Select the desired new setting, e.g. Spanish (ESPAÑOL) using the turn control.

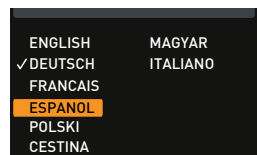

3. Save the setting by pressing the confirmation key.

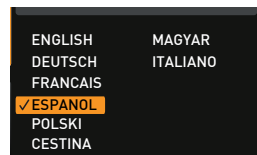
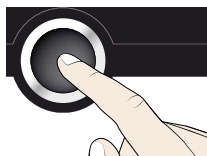

4. To return to the menu overview, press the activation key again.

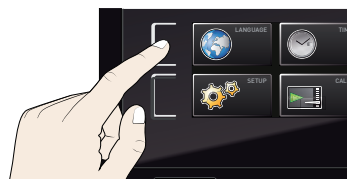

You can now

- ▶ activate another menu function by pressing the corresponding activation key or
- ▶ return to operating mode by pressing the MENU key.

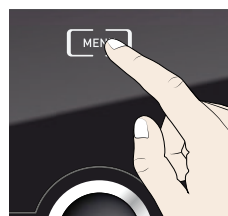
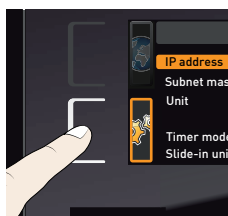

All other settings can be made accordingly. The settings possible are described in the following sections.

**1** If no new values are entered or confirmed for approx. 30 seconds, the appliance automatically restores the former values.

### 7.3 Setup

In the SETUP display, you can set the following parameters:

- ▶ the IP address and subnet mask of the appliance's Ethernet interface (for connection to a network)
- ▶ The units of the temperature display (°C or °F, see page 33)
- ▶ The trigger temperature of the monitoring function (Max Alarm, see page 34).
- ▶ How the digital backwards counter with target time setting works (Timer Mode, see page 34).
- ▶ The type of slide-in unit (grid or shelf, see page 35)
- ▶ Remote control (see page 35)
- ▶ Gateway (see page 35)

**1** If the Setup menu contains more entries than can be displayed, this is indicated by the display "1/2". This means that there is a second "page" of entries.

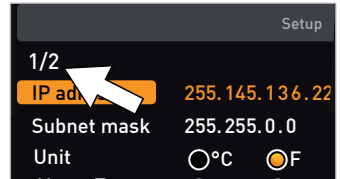

To display the hidden entries, use the turn control to scroll beyond the lowest entry. The page display changes to "2/2".

#### 7.3.1 IP address and subnet mask

If you want to operate one or more appliances in a network, each appliance must have its own unique IP address for identification. By default, each appliance is delivered with the IP address 192.168.100.100.

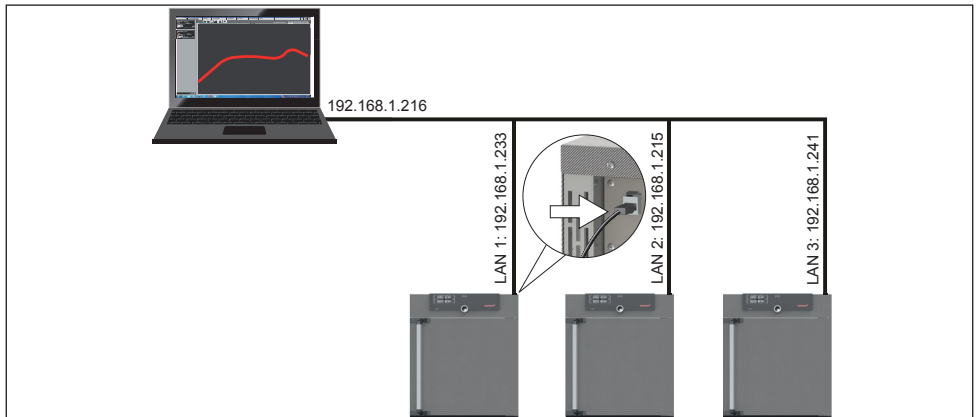
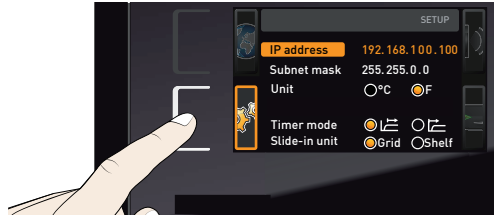

Fig. 19 Operation of several appliances in a network (schematic example)



1. Activate the SETUP display. The entry IP address is automatically high-lighted.



2. Accept the selection by pressing the confirmation key. The first three digits of the IP address are automatically selected.

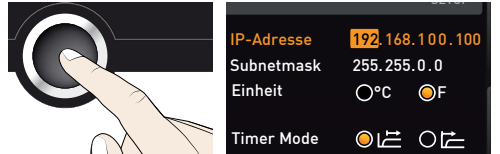

3. With the turn control, set the new number, e.g. 255.

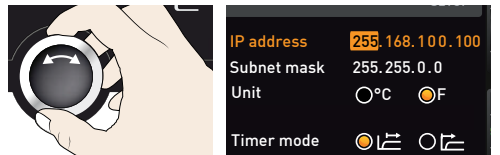

4. Accept the selection by pressing the confirmation key. The next three digits of the IP address are automatically selected. Setting these is done according to the description above.

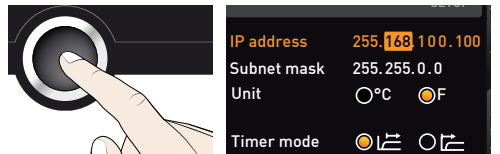

5. After setting the last three digits, accept the new IP address by pressing the confirmation key. The selection returns to the overview.

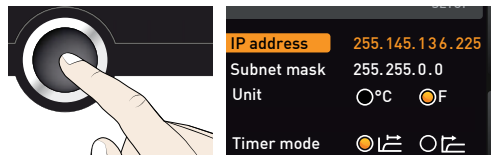

The subnet mask is set accordingly.

### 7.3.2 Units

Here, you can choose whether the temperature is displayed in °C or °F.

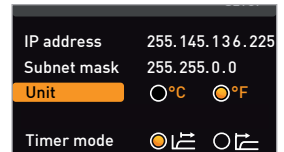

### 7.3.3 Temperature monitoring (Max Alarm)

Here, you can set the trigger temperature of the automatic temperature monitoring system (Max Alarm).

**1** The monitoring temperature must be set sufficiently high above the maximum set temperature. We recommend 1 to 3 K difference.

1. Use the turn control to select MaxAlarm.

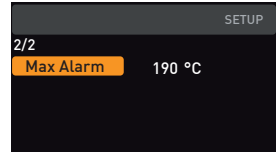

2. Accept the selection by pressing the confirmation key. The current settings are automatically highlighted.

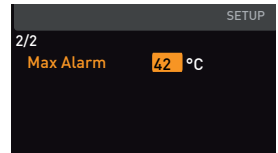
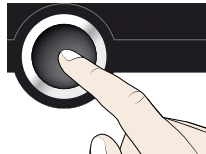

3. Use the turn control to set the desired new trigger temperature – in this example 39 °C.

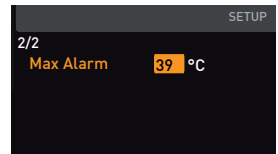

4. Save the setting by pressing the confirmation key. The electronic temperature monitoring system will now be triggered when the actual temperature reaches 39 °C.

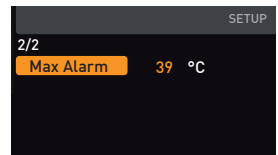
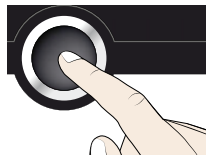

### 7.3.4 Timer mode

Here, you can choose whether the digital backwards counter with target time setting (see page 25, timer) should be setpoint-dependent or not – this determines whether the timer should not start until a tolerance band of  $\pm 3$  K around the set temperature is reached (Fig. 20, B) or whether it should start immediately after activation (A).

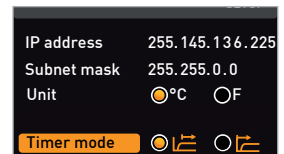

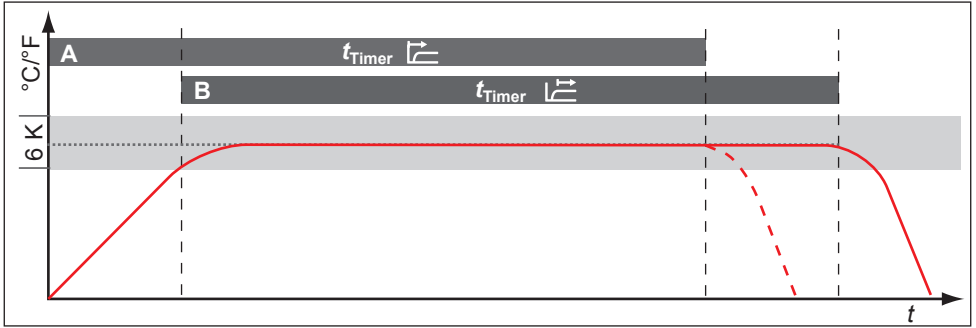
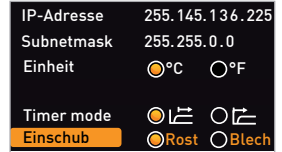

Fig. 20 Timer mode  
 A Timer independent of setpoint: Timer starts right after activation  
 B Timer setpoint-dependent: Timer does not start until tolerance band is reached

If the temperature tolerance band is exceeded in setpoint-dependent operation, the timer will be interrupted and only be resumed when the setpoint temperature has been reached again.

### 7.3.5 Slide-in unit type (steel grid or shelf)

Here, you have to select the type of slide-in unit (steel grid or shelf) used. The selection Shelf enables you to adjust the control function to the different air flow characteristics in the interior when using optional sliding shelves instead of the steel grids that are provided as standard.



### 7.3.6 Remote control

In the setup entry remote control, you can set whether the appliance should be controlled via remote control and, if so, in which mode. These settings are available:

- ▶ Off
- ▶ Read only
- ▶ Write + Read
- ▶ Write + Alarm

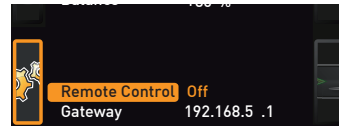

When the appliance is in remote control mode, the following symbol  is displayed on the temperature display: In the settings Write + Read and Write + Alarm, the appliance cannot be controlled at the ControlCOCKPIT until the remote control has been switched off (setting Off) or set to Read only.

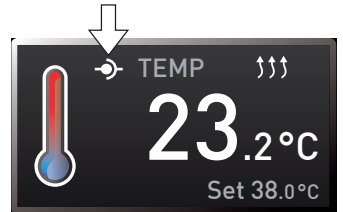

 In order to use the remote control function, programming skills and special libraries are required.

### 7.3.7 Gateway

The setup entry gateway is used to connect two networks with different protocols.

The gateway is set the same way as the IP address (see page 32).

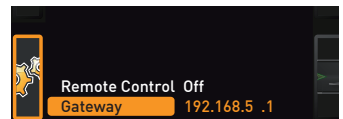

## 7.4 Date and time

In the TIME display, you can set the date and time, time zone and daylight saving time. Changes can only be made in manual operating mode.

**1** Always set the time zone (and daylight saving time yes/no) before setting the date and time. Avoid changing the set time after that since this can lead to gaps or overlapping when recording measured values. If you still need to change the time, you should not run a programme immediately before or after doing so.

1. Activate the time setting. To do so, press the activation key on the right side of the TIME display. The display is enlarged and the first adjustment option (Date) automatically highlighted.

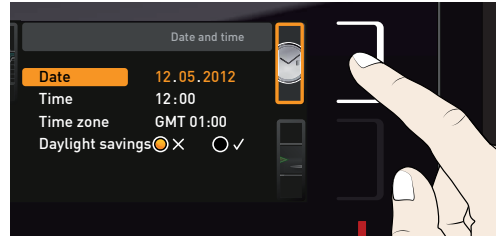

2. Turn the turn control until Time zone is highlighted.

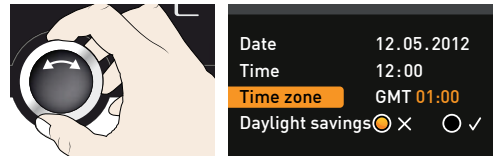

3. Accept the selection by pressing the confirmation key.

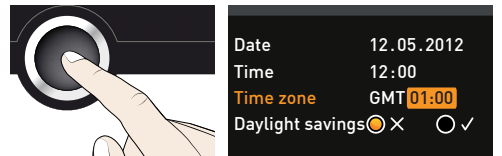

4. Set the time zone of the installation site with the turn control, e.g. 00:00 for Great Britain, 01:00 for France, Spain or Germany. Accept the selection by pressing the confirmation key.

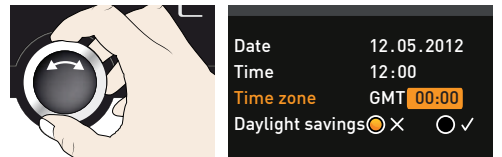

5. With the turn control, select the Daylight savings entry.

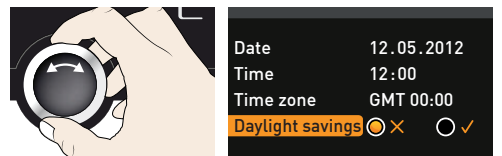

6. Accept the selection by pressing the confirmation key. The adjustment options are highlighted.

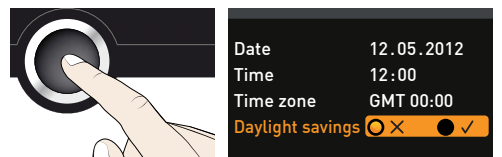

7. Set daylight savings to off (X) or on (✓) with the turn control – in this case on (✓). Save the setting by pressing the confirmation key.



**i** Daylight saving time and standard time are not changed automatically. For this reason, please keep in mind to adjust them at the beginning of each period.

8. Now, set date (day, month year) and time (hours, minutes) in the same way. Accept the selection by pressing the confirmation key.

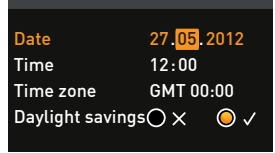

## 7.5 Calibration

The appliances are temperature calibrated and adjusted at the factory. In case readjustment should be necessary later on – for example due to influence of the chamber load – the appliance can be calibrated customer-specifically using three calibration temperatures of your choice:

- ▶ Cal1 Temperature calibration at low temperature
- ▶ Cal2 Temperature calibration at medium temperature
- ▶ Cal3 Temperature calibration at high temperature

To guarantee perfect control, we recommend to calibrate the appliance once a year.

**i** For temperature calibration, you will need a calibrated reference measuring device.

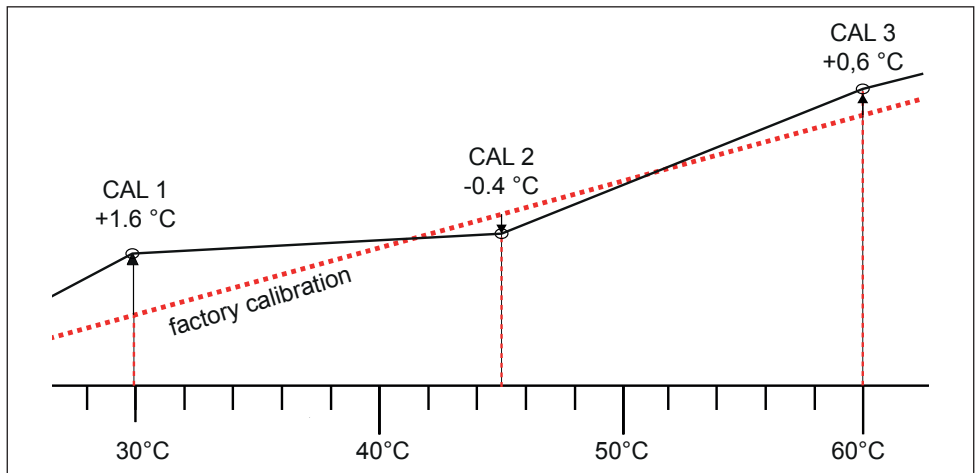
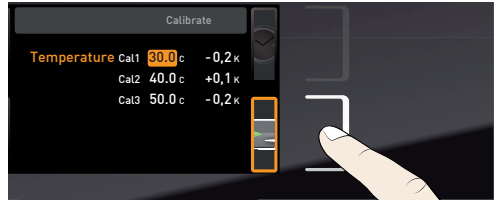

Fig. 21 Schematic example of temperature calibration

Example: Temperature deviation at 42 °C should be corrected.

1. Activate the adjustment setting. To do so, press the activation key on the right of the CALIB display. The display is enlarged and the first calibration temperature – in this case 30 °C – automatically highlighted.



2. Press the confirmation key repeatedly, until the calibration temperature Cal2 is selected.

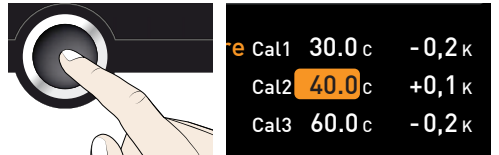

3. With the turn control, set the calibration temperature Cal2 to 42 °C.

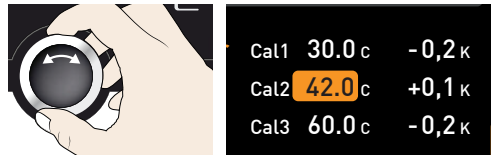

4. Save the setting by pressing the confirmation key. The corresponding calibration value is automatically highlighted.

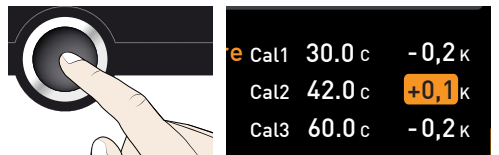

5. Set the calibration value to 0.0 K and accept the setting by pressing the confirmation key.

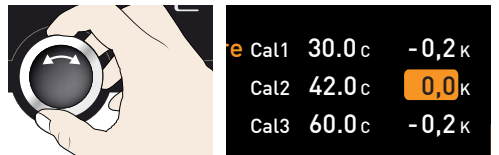

6. Position the sensor of a calibrated reference instrument centrally in the appliance's working chamber.

7. Close the door and, in manual mode, adjust the set temperature to 42 °C.

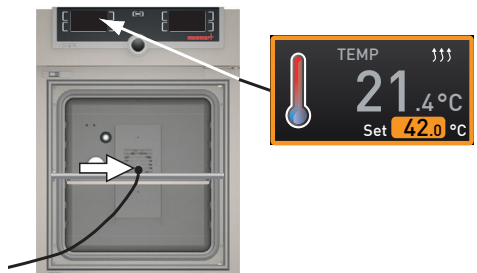

8. Wait until the appliance reaches the set temperature and displays 42 °C. The reference instrument displays 43.6 °C for example.



9. In the SETUP, adjust the calibration value Cal2 to +1.6 K (actual value measured minus setpoint temperature) and save the setting by pressing the confirmation key.



Cal1	30.0c	-0,2 K
Cal2	42.0c	+1,6 K
Cal3	60.0c	-0,2 K

10. After the calibration procedure, the temperature measured by the reference instrument should now also be 42 °C.

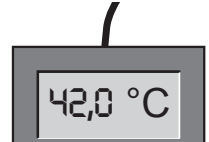
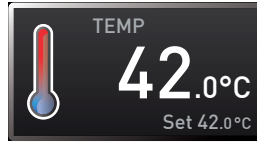

With Cal1, a calibration temperature below Cal2 can be programmed accordingly, and with Cal3, a temperature above. The minimum interval between the Cal values is 10 K.

**i** If all calibration values are set to 0.0 K, the factory calibration settings are restored.

## 8. Maintenance and Servicing

---

**⚠ WARNING**

Risk of electric shock. Disconnect the mains plug before any cleaning or maintenance work.

---

**⚠ WARNING**

With appliances above a specific size, you could become accidentally locked inside, which could put you at risk of death. Do not climb into the appliance!

---

**⚠ CAUTION**

Danger of cuts due to sharp edges. Always wear gloves when working inside the chamber.

---

### 8.1 Cleaning

#### 8.1.1 Interior and metal surfaces

Regular cleaning of the easy-to-clean interior prevents build up of material remains that could impair the appearance and functionality of the stainless steel chamber over time. The metal surfaces of the appliance can be cleaned with normal stainless steel cleaning agents. Make sure that no rusty objects come into contact with the interior or with the stainless steel housing. Rust deposits can lead to an infection of the stainless steel. If rust spots should appear on the surface of the interior due to impurities, the affected area must be immediately cleaned and polished.

#### 8.1.2 Plastic parts

Do not clean the ControlCOCKPIT and other plastic parts of the appliance with caustic or solvent-based cleaning agents.

#### 8.1.3 Glass surfaces

Glass surfaces can be cleaned with a commercially available glass cleaner.

### 8.2 Regular maintenance

Once a year, grease the moving parts of the doors (hinges and lock) with thin silicone grease and check that the hinge screws are not loose.

To guarantee perfect control, we recommend calibrating the appliance once a year (see page 37).



## 8.3 Repairs and Service

---

**⚠ WARNING**

Live parts may be exposed once the covers have been removed. Touching these can lead to an electrical shock. Disconnect the mains plug before removing any covers. Any work inside the appliance may only be performed by qualified electricians.

---



Repairs and service work are described in a separate service manual.

## 9. Storage and disposal

### 9.1 Storage

The appliance may only be stored under the following conditions:

- ▶ in a dry and enclosed, dust-free room
- ▶ frost-free
- ▶ disconnected from the power supply

### 9.2 Disposal

This product is subject to Directive 2012/19/EC on Waste Electrical and Electronic Equipment (WEEE) of the European Parliament and of the Council of Ministers. This appliance was placed on the market after August 13<sup>th</sup>, 2005 in countries which have already integrated this Directive into their national laws. It may not be disposed of in normal household waste. For disposal, please contact your dealer or the manufacturer. Any appliances that are infected, infectious or contaminated with materials hazardous to health are excluded from return. Please also observe all other regulations applicable in this context.

Before disposing of the appliance, please render the door locking mechanism unusable, for example to prevent playing children from being locked inside the appliance.

There is a lithium battery in the ControlCOCKPIT of the appliance. Remove it and dispose of it in accordance with the regulations in your country (Fig. 22).

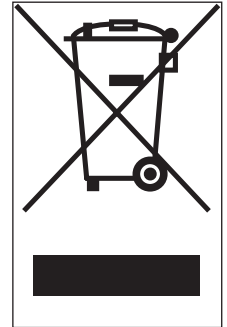

Fig. 22 Removing the lithium battery

---

## Index

---

- A**  
Accessories 13  
Activation button 23  
Adjusting doors 19  
Adjustment 37  
Air supply 10  
Alarm 34  
Alarm temp 34  
Ambient conditions 13  
Ambient temperature 13  
Appliance error 28  
AtmoCONTROL 3, 11, 13
- B**  
Basic appliance settings 30  
Basic settings 30
- C**  
Calibration 37  
Carrying 14  
Cause of error 28  
Changes 8  
Cleaning 40  
Communication interfaces 11  
Compensation correction values 39  
Connections 11  
ControlCOCKPIT 23  
Convection 10  
Customer service 2
- D**  
Date 36  
Declaration of conformity 13  
Delivery 14, 15, 20  
Digital backwards counter with target time setting 25  
Dimensions 12  
Disposal 42  
Door 21
- E**  
Electrical connection 11  
Electrical connections 20  
Electronic temperature monitoring 26  
Emergency 8  
Ending operation 27  
Error description 28  
Error message 29  
Error messages 28
- F**  
Fan speed 25  
Forklift truck 15  
Function 10
- G**  
Gateway 35  
Graph 27
- H**  
Hazards 7
- I**  
Installation site 16  
Intended use 10  
Interfaces 11  
IP address 32
- L**  
Language selection 31  
Loading the appliance 22  
Log memory 29
- M**  
Maintenance 40  
Malfunctions 8, 28  
Manufacturer 2  
Material 10  
Max Alarm 34  
Mechanical temperature monitoring 27  
Menu 30  
Minimum clearances 16  
Monitoring temperature 26
- N**  
Network 11, 32  
Normal mode 24
- O**  
Operating mode 23  
Operating modes 24  
Operating personnel 7, 21  
Operating problems 28  
Operation 21
- P**  
Packaging material 15  
Parameter adjustment 23, 31  
Power failure 29  
Product safety 7  
PT100 temperature sensor 26  
Putting into operation 20
- R**  
Regular maintenance 40  
Remote control 35
- S**  
Safety regulations 6, 9  
Service 41  
Servicing 41  
Setting up 14, 16  
Set type of slide-in unit 35  
Setup 32  
Shelf 35  
Slide-in unit 35  
Steel grid 35  
Storage after delivery 15  
Switching off 27  
Switching on 20
- T**  
Taking out of service 42  
TB 27  
Technical data 12  
Temperature 24  
Temperature comparison 37  
Temperature deviation 38  
Temperature limiter 27  
Temperature monitoring 26, 34  
Temperature sensor 26  
Tilt protection 18  
Time 35, 36  
Timer mode 34  
Transport 14, 15  
Transport damage 15  
Troubleshooting 28  
Turn control 24  
TWW 26

Type plate 11

**U**

Unit 33

Unpacking 15

**W**

Warning messages 11, 28

Weight 12







# memmert

IF - Blanket warmer

D39065 | Date 01/2020

Englisch

Memmert GmbH + Co. KG  
Postfach 1720 | D-91107 Schwabach  
Tel. +49 9122 925-0 | Fax +49 9122 14585  
E-Mail: [sales@memmert.com](mailto:sales@memmert.com)  
[facebook.com/memmert.family](https://facebook.com/memmert.family)